

FUNDAMENTALS OF MAGNETISM AND MAGNETIC MEASUREMENTS

FEATURING QUANTUM DESIGN'S MAGNETIC PROPERTY MEASUREMENT SYSTEM

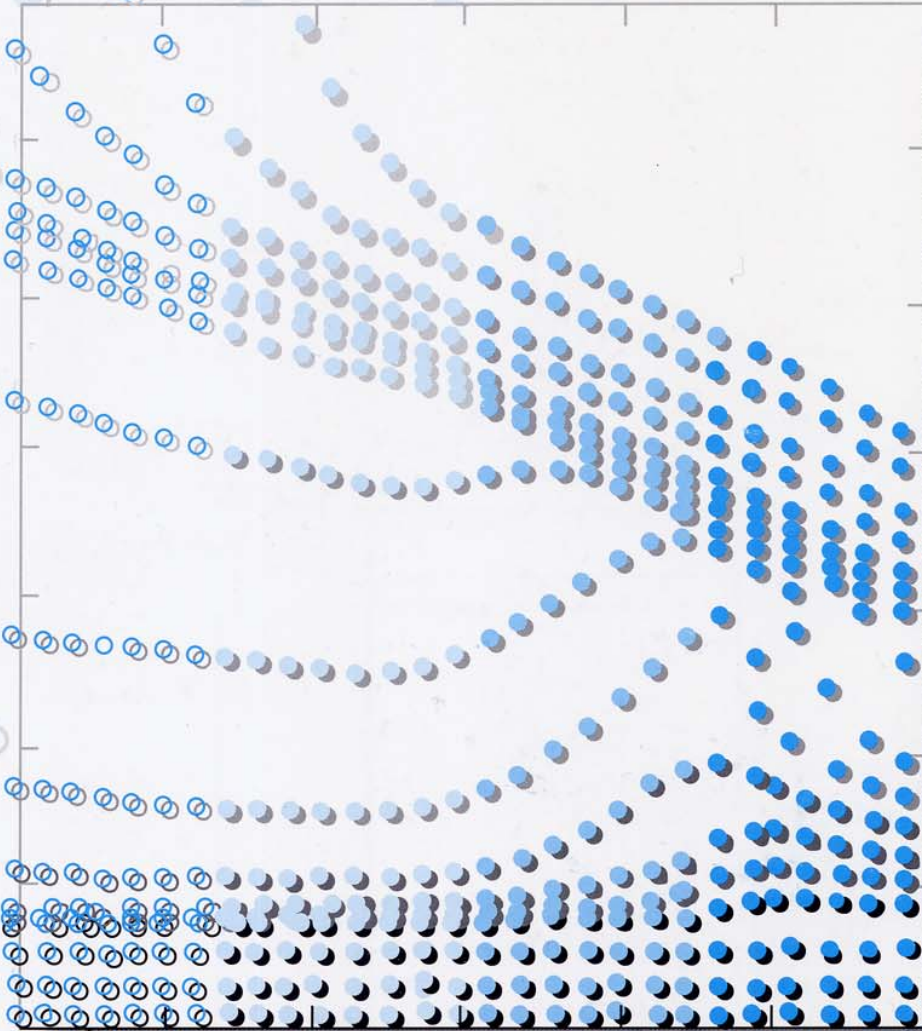

BY MIKE McELFRESH, PURDUE UNIVERSITY

MPMS SYSTEM COMPONENTS

SYSTEM COMPONENTS (superconducting components shown in blue)

- | | | |
|-----------------------------|---------------------------------------|--------------------------------|
| 1. Sample Rod | 8. SQUID Capsule with Magnetic Shield | 15. Console Cabinet |
| 2. Sample Rotator | 9. Superconducting Pick-up Coil | 16. Power Distribution Unit |
| 3. Sample Transport | 10. Dewar Isolation Cabinet | 17. Model 1822 MPMS Controller |
| 4. Probe Assembly | 11. Dewar | 18. Gas/Magnet Control Unit |
| 5. Helium Level Sensor | 12. HP Thinkjet Printer | 19. HP Vectra Computer |
| 6. Superconducting Solenoid | 13. Magnet Power Supply | 20. Monitor |
| 7. Flow Impedance | 14. Model 1802 Temperature Controller | |

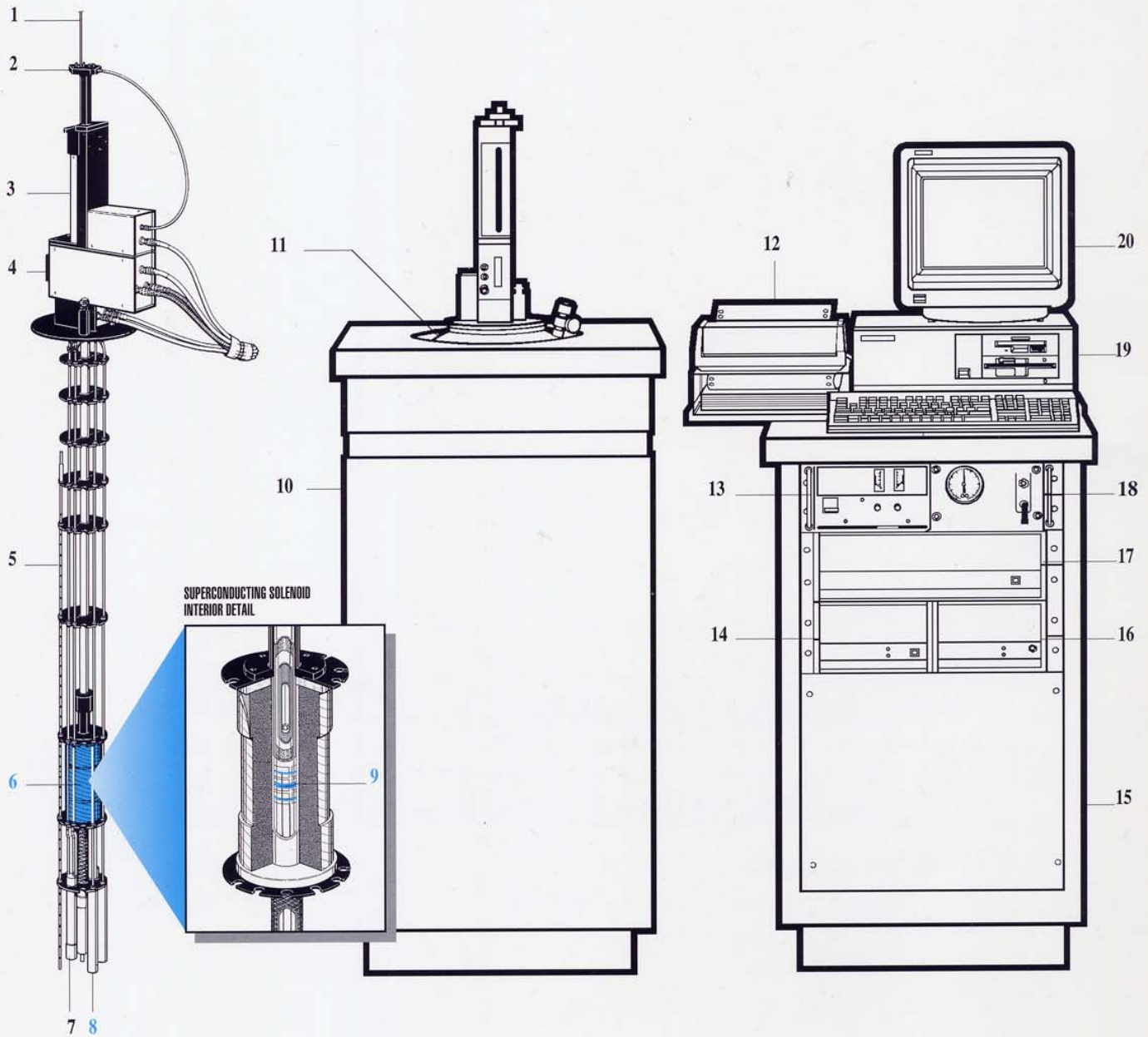

FUNDAMENTALS OF MAGNETISM

AND

MAGNETIC MEASUREMENTS

FEATURING QUANTUM DESIGN'S

MAGNETIC PROPERTY MEASUREMENT

SYSTEM

BY MIKE McELFRESH
PURDUE UNIVERSITY



TABLE OF CONTENTS

PART I: INTRODUCTION TO THE QUANTUM DESIGN MAGNETIC PROPERTY MEASUREMENT SYSTEM.....	5
A. SUPERCONDUCTING COMPONENTS	5
THE SQUID	5
THE SUPERCONDUCTING SHIELD	6
THE SUPERCONDUCTING DETECTION COIL	6
THE SUPERCONDUCTING MAGNET	7
B. SAMPLE SPACE AND TEMPERATURE CONTROL	9
C. THE MEASUREMENT PROCEDURE	10
SAMPLE TRANSPORT	10
OUTPUT OF SIGNAL ANALYSIS	11
MODES FOR OPERATION OF THE MAGNET	12
FURTHER INFORMATION	12
D. ENGINEERING DESIGN TRADEOFFS	12
THE SAMPLE CHAMBER	12
THE DETECTION COIL	13
THE SUPERCONDUCTING MAGNET	13
 PART II. MAGNETIC UNITS OF MEASURE	 15
 PART III. TYPES OF MAGNETIC BEHAVIOR	 17
A. PARAMAGNETISM	17
INTRODUCTION	17
<i>Curie-Type Paramagnetism</i>	18
UNITS	18
EXAMPLES AND ADVANCED TOPICS	18
<i>Curie Paramagnetism</i>	18
OTHER TYPES OF PARAMAGNETISM	19
<i>Curie-Weiss Paramagnetism</i>	19
<i>Pauli Paramagnetism and Van Vleck Paramagnetism</i>	20
<i>Combinations</i>	20
B. DIAMAGNETISM	20
C. FERROMAGNETISM	21
INTRODUCTION	21
UNITS	22
EXAMPLES AND ADVANCED TOPICS	23
<i>History Dependence</i>	23
<i>Magnetic Domains</i>	24
<i>Magnetic Recording and Transformer Coils</i>	25

D. ANTIFERROMAGNETISM AND FERRIMAGNETISM	25
ANTIFERROMAGNETISM	25
FERRIMAGNETISM	26
UNITS	26
E. SUPERCONDUCTIVITY	26
INTRODUCTION	26
UNITS	28
EXAMPLES AND ADVANCED TOPICS	28
<i>Irreversibility Line</i>	28
<i>Minor Loops</i>	29
<i>Time Dependence</i>	30
F. DEMAGNETIZATION CORRECTIONS	30
G. MAGNETIC CHARACTERIZATION OF A NEW MATERIAL	31
PART IV: APPENDICES	33
A. TABLE OF CONVERSIONS	33
B. RECOMMENDED READING	34

AUTHOR'S PREFACE AND ACKNOWLEDGMENTS

I was very pleased when Barry Lindgren, the President of Quantum Design, offered me the chance to put down in writing information that I consider practical and valuable, yet which has no particular place in the published literature. This information was acquired over many years, mostly through numerous discussions with colleagues in the research community and those at Quantum Design. I have tried to make it accessible to people with a wide range of backgrounds, hoping to shorten the learning curve for those developing the techniques required to make meaningful measurements of magnetic phenomena.

In the first part of this primer I have tried to introduce the significant components that make up the MPMS and then explain their function. I have attempted to distinguish those features that are unique to the MPMS, and those common to all magnetometers. In the second part, I have tried to provide those with little experience in the measurement of the magnetic properties of materials with a simple introduction that I hope will help them acquire the language, and some of the fundamental principles, that will make further reading more productive. By no means is it meant to be a complete treatment of the subject matter, but rather a simple, practical introduction.

My special thanks go to Ron B. Goldfarb of the National Institute of Standards and Technology in Boulder, Colorado, for his suggestions, comments and corrections. I also was fortunate to have the assistance of John R. Clem of Iowa State University. Ron Sager of Quantum Design offered many illuminating insights on design aspects of the magnetometer itself. Finally, my appreciation goes to numerous members of the QD technical, sales and customer service groups, who helped with some of the figures, and provided valuable critiques and suggestions as to content and presentation.

Quantum Design's Magnetic Property Measurement System (MPMS) is a highly integrated instrument system, designed to be a primary research tool in the complicated study of magnetism in matter. The magnetic signature of a material reflects its intrinsic spin and orbital angular momentum. In the case of a material that would normally be recognized as strongly magnetic, i.e., the ferromagnets used in electric motors or the material used on magnetic recording tape, determining a "magnetization curve" over a range of applied magnetic fields will help establish its commercial value for a particular application. For other materials, those that might be characterized by most people as "non-magnetic," a similar investigation might reveal information about electronic structure, interactions between neighboring molecules or the character of a transition between two phases of the material.

When first brought to market, the Model MPMS was unique in that it incorporated a high degree of integration and automation in an instrument that represented the state of the art in superconducting technology. The principal components of this measurement system comprise the following:

- 1) **Temperature Control System.** Precision control of the sample temperature in the range 2 K (-271 °C) to 400 K (127 °C). This requires controlling heat flow into the sample space and the active control of gas to provide cooling power.
- 2) **Magnet Control System.** Current from a power supply is set to provide magnetic fields from zero to positive and negative seven teslas. The magnet can be operated in either persistent or non-persistent modes, and several charging options can be selected by the user.
- 3) **Superconducting SQUID Amplifier System.** The rf SQUID detector is the heart of the magnetic moment detection system. It provides reset circuitry, auto-ranging capability, a highly balanced second-derivative sample coil array and EMI protection.
- 4) **Sample Handling System.** The ability to step and rotate the sample smoothly through the detection coils without transmitting undue mechanical vibration to the SQUID is of primary importance. This facility allows for varied scan lengths and options as to how data are acquired for a given measurement.
- 5) **Computer Operating System.** All operating features of the MPMS are under automated, computer control. The user interface at the PC console provides the option of working under standard sequence controls, or diagnostic controls which will invoke individual functions.

The Model MPMS sample magnetometer is currently used in research laboratories worldwide, and is specified for experimental and materials characterization tasks that require the highest detection sensitivities over a broad temperature range, and in applied magnetic fields to seven teslas. It is configured to detect the *magnetic moment* of a sample of material, from which the magnetization and magnetic susceptibility can be determined. For the MPMS, superconductivity is the critical enabling technology that provides for both the production of large, very stable magnetic fields, and the ability to measure changes in those fields which are 14 orders of magnitude smaller.

The superconducting state, first observed in mercury by Heike Kamerlingh-Onnes in 1911, is a phase in a material for which, below some critical temperature T_c , the electrical resistance of that material falls abruptly to zero. Many metals exhibit this phase change at various temperatures ranging from less than 1 K (-272 °C, -458 °F) for zinc to about 23 K (-255 °C, -427 °F) for an alloy of niobium and germanium (Nb₃Ge). Unfortunately, the only economical way to provide cooling to these temperatures is to immerse the material of choice in a vacuum-shrouded vessel of liquid helium or liquid hydrogen (which have boiling points at standard atmospheric pressure of 4.2 K and 20.3 K, respectively), cryogenics which are both costly and difficult to handle.

The first and most obvious benefit of a superconducting material is that large amounts of electrical current can be passed through it without dissipating energy in the form of heat. Many so-called large scale applications that require sizable magnetic fields such as metals separation technology, medical Magnetic Resonance Imaging (MRI) and magnetic energy storage, become practical to implement with the availability of superconducting wire. Also, the prospect of transmitting large amounts of electrical energy long distances without ohmic loss has continued to be a topic of on-going debate and interest, as new materials and better refrigeration techniques become available.

Another extremely important part of small-scale superconducting technology is the Josephson junction, a device based on a Nobel prize winning tunneling effect proposed in theory by B.D. Josephson in 1962, and observed experimentally in 1964 by Anderson and Rowell. Josephson junctions have been long-studied in superconducting computing circuits and can perform as digital switching elements capable of changing states in a few picoseconds. These remarkable structures allow direct observation of quantum electrodynamic phenomena. In one configuration, as a series array of thousands of identical junctions, it is possible to construct a primary voltage calibration standard, based upon the ratio $2e/h$.

A more common use of the Josephson junction is in a device called a SQUID (Superconducting QUantum Interference Device). A SQUID device consists of a closed superconducting loop including one or two Josephson junctions in the loop's current path. Because of the quantized state of the superconducting ring, and the extraordinary non-linear behavior of the Josephson junction, the SQUID is capable of resolving changes in external magnetic fields that approach 10^{-15} tesla, yet can be made to operate in fields as large as 7 teslas. These powerful measuring devices, which have been used in laboratory measurements for many years, were first introduced as commercial devices in 1970. They have been configured as picovoltmeters, magnetometers to measure the small changes in the earth's magnetic field and magnetic gradiometers sensitive enough to measure the small magnetic fields around the human heart and brain. It is an rf SQUID device which gives the Model MPMS its extraordinary sensitivity to the magnetic moment of materials.

Beyond the niobium compounds that are now quite common in the construction of superconducting magnets and the thin film amplifiers called SQUIDs, there is also now a new class of ceramic materials — an example being the yttrium barium copper oxides — under intense scientific investigation as the commercial superconductors of the future. These substances exhibit T_c 's in excess of 90 K (-183 °C, -298 °F), and therefore begin to offer the promise of achieving zero resistance with advanced refrigeration techniques, rather than exotic liquid cryogenics like liquid helium. Interestingly, the Model MPMS, based firmly in low- T_c technology, provided the combination of sensitivity, automation and wide temperature ranges necessary to study the higher-temperature characteristics of these remarkable new materials.

A. SUPERCONDUCTING COMPONENTS

The MPMS system includes several different superconducting components:

- a superconducting **magnet** to generate large magnetic fields,
- a superconducting **detection coil** which couples inductively to the sample,
- a Superconducting **QUantum Interference Device (SQUID)** connected to the detection coil,
- a superconducting **magnetic shield** surrounding the SQUID.

The locations of the various components are shown in Figure 1 at the front of this primer.

THE SQUID

A SQUID is the most sensitive device available for measuring magnetic fields, and, although the SQUID in the MPMS is the source of the instrument's remarkable sensitivity, it does not detect directly the magnetic field from the sample. Instead, the sample moves through a system of superconducting detection coils which are connected to the SQUID with superconducting wires, allowing the current from the detection coils to inductively couple to the SQUID sensor. When properly configured, the SQUID electronics produces an output voltage which is strictly proportional to the current flowing in the SQUID input coil. Hence, the thin film SQUID device, which is located approximately 11 cm below the magnet inside a superconducting shield, essentially functions as an extremely sensitive current-to-voltage convertor.

A measurement is performed in the MPMS by moving a sample through the superconducting detection coils, which are located outside the sample chamber and at the center of the magnet. As the sample moves through the coils, the magnetic moment of the sample induces an electric current in the detection coils. Because the detection coils, the connecting wires, and the SQUID input coil form a closed superconducting loop, any change of magnetic flux in the detection coils produces a change in the persistent current in the detection circuit, which is proportional to the change in magnetic flux. Since the SQUID functions as a highly linear current-to-voltage convertor, the variations in the current in the detection coils produce corresponding variations in the SQUID output voltage which are proportional to the magnetic moment of the sample. In a fully calibrated system, measurements of the voltage variations from the SQUID detector as a sample is moved through the detection coils provide a highly accurate measurement of the sample's magnetic moment. The system can be accurately calibrated using a small piece of material having a known mass and magnetic susceptibility.

A. SUPERCONDUCTING COMPONENTS

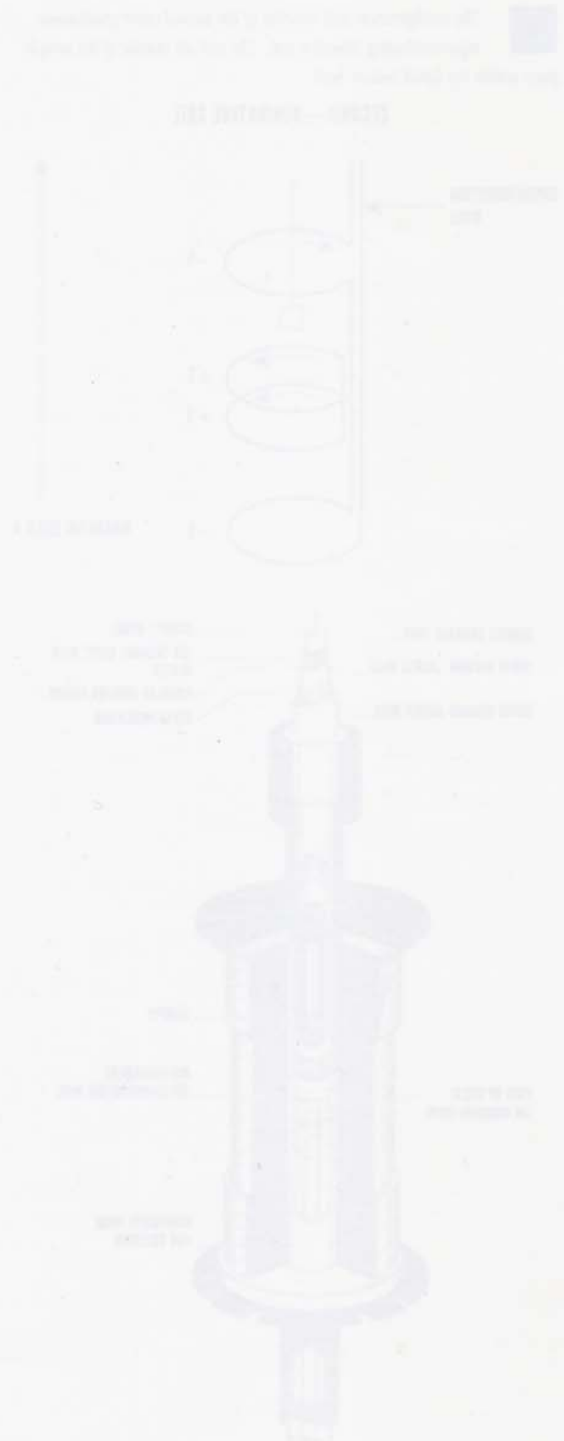

2 The configuration and location of the second-order gradiometer superconducting detection coil. The coil sits outside of the sample space within the liquid helium bath.

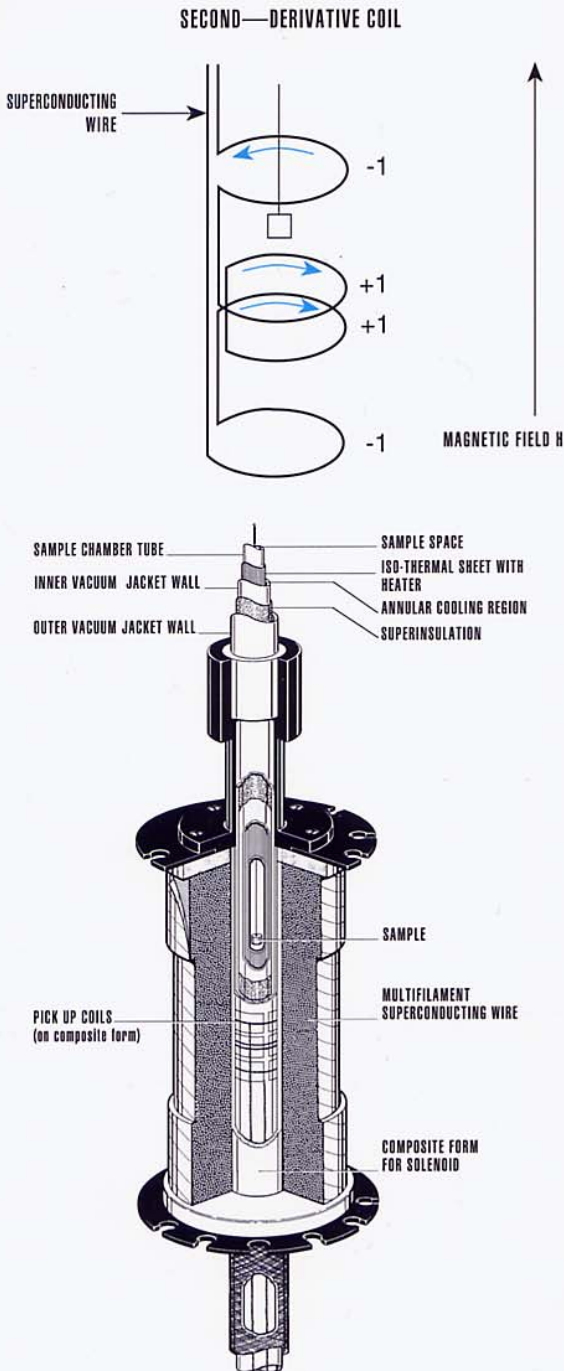

THE SUPERCONDUCTING SHIELD

Because of the SQUID's extreme sensitivity to fluctuations in magnetic fields, the sensor itself must be shielded both from fluctuations in the ambient magnetic field of the laboratory and from the large magnetic fields produced by the superconducting magnet. The requisite magnetic shielding is provided by the superconducting shield which provides a volume of relatively low magnetic field in which the SQUID and its coupling transformers are located. Proper operation of the SQUID does not necessarily require that the magnetic field inside the shield be extremely small, but it does require that any field inside the shield be extremely stable. Consequently, the superconducting shield serves two purposes in the MPMS:

1. To shield the SQUID detector from the magnetic field generated by the superconducting magnet.
2. To trap and stabilize the ambient laboratory magnetic field present when the SQUID and the superconducting shield are first cooled to liquid helium temperature.

The requirement for the superconducting shield can be more readily appreciated when one considers the sensitivity of the SQUID detector. The magnetic flux produced in the SQUID by a typical small sample is of the order of one-thousandth of a flux quantum, where the flux quantum is $2.07 \times 10^{-7} \text{ G-cm}^2$. For comparison, the magnetic flux through a 1 cm^2 area in the earth's magnetic field corresponds to about 2 million flux quanta.

THE SUPERCONDUCTING DETECTION COIL

The detection coil is a single piece of superconducting wire wound in a set of three coils configured as a second-order (second-derivative) gradiometer. In this configuration, shown in Figure 2, the upper coil is a single turn wound clockwise, the center coil comprises two turns wound counter-clockwise, and the bottom coil is a single turn wound clockwise. When installed in the MPMS, the coils are positioned at the center of the superconducting magnet outside the sample chamber such that the magnetic field from the sample couples inductively to the coils as the sample is moved through them. The gradiometer configuration is used to reduce noise in the detection circuit caused by fluctuations in the large magnetic field of the superconducting magnet.

The gradiometer coil set also minimizes background drifts in the SQUID detection system caused by relaxation in the magnetic field of the superconducting magnet. Ideally if the magnetic field is relaxing uniformly, the flux change in the two-turn center coil will be exactly canceled by the flux change in the single-turn top and

bottom coils. On the other hand, the magnetic moment of a sample can still be measured by moving the sample through the detection coils because the counterwound coil set measures the local changes in magnetic flux density produced by the dipole field of the sample. In this application a second-order gradiometer (with three coils) will provide more noise immunity than a first-order gradiometer (with two coils), but less than a third-order gradiometer (which would employ four coils).

It is important to note that small differences in the area of the counterwound coils will produce an imbalance between the different coils, causing the detection coil system to be somewhat sensitive to the magnetic field from the superconducting magnet. In practice, it is never possible to get the coils exactly balanced against the large fields produced by the magnet, so changes in the magnetic field will always produce some current in the detection coil circuit. Over long periods of time and many measurements, large persistent currents can build up in the detection coil, producing noise in the system when these large currents flow in the SQUID input coil. The MPMS system prevents this from occurring by heating a small section of the detection coil circuit whenever the magnetic field is being changed.

THE SUPERCONDUCTING MAGNET

The MPMS system employs a superconducting magnet wound in a solenoidal configuration. An important feature of the MPMS is that the magnet is constructed as a completely closed superconducting loop, allowing it to be charged up to a specific current, then operated during a measurement in *persistent mode* without benefit of an external current source or power supply. To charge the magnet up to a specific current, or to change the current in the magnet when a persistent current is already flowing, the closed superconducting loop must be electrically opened by using a persistent-current switch, formed by wrapping a small heater around a short segment of the magnet's superconducting wire. When the heater is energized, the segment of wire within the heater becomes normal (no longer superconducting), thereby electrically opening the closed superconducting loop. By attaching a power supply (which essentially functions as a current source) to each side of the switch, it becomes possible to change the current in the superconducting magnet.

While the current in the magnet is being provided by the power supply, the SQUID detection system in the MPMS will display a high level of noise. The detection system noise arises from fluctuations in the magnetic field of the magnet produced by current fluctuations in the current source. However, once the magnetic field is at the desired level, the switch heater can be turned off allowing the switch to return to the superconducting state. In this condition, the current from the power

A. SUPERCONDUCTING COMPONENTS

supply can be turned off and the power supply completely disconnected from the system, while the supercurrent continues to flow in the magnet, sustaining the desired magnetic field. This condition is typically referred to as operating the magnet in the persistent mode. A schematic diagram of the charging procedure with zero initial current in the magnet is shown in Figure 3.

3 Sequence of steps involved in initially setting the field in a superconducting magnet. **A)** The persistent current switch is turned "on" opening the superconducting loop. **B)** The current from the power supply to the magnet is ramped to the desired level. **C)** The persistent switch is turned "off". The superconducting loop is closed, but the power supply remains energized. **D)** The current from the power supply is ramped to zero leaving the current running in the closed superconducting loop.

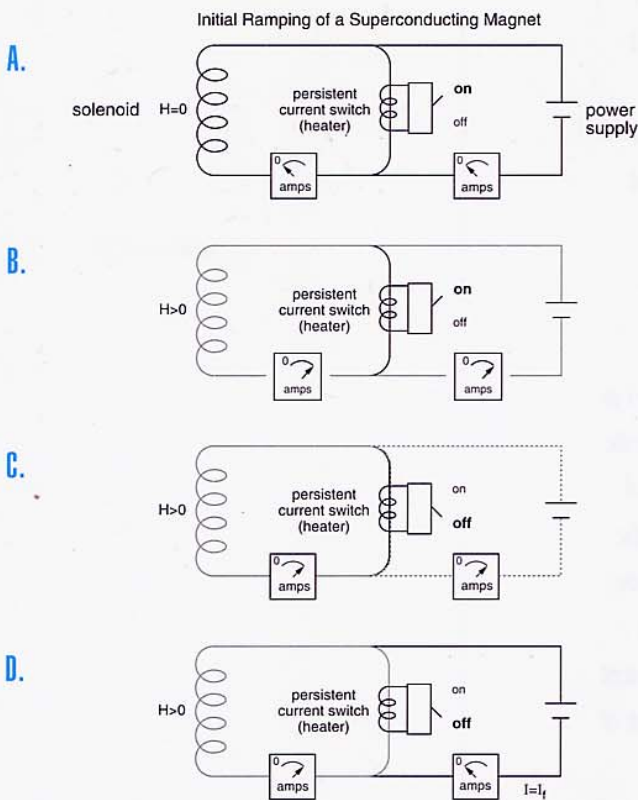

After the power supply is disconnected and the magnet has been placed in the persistent mode, additional time may still be required before the field in the magnet becomes fully stable. During the charging process, the magnet current is changing and the magnetic field is forced to move through the superconducting windings, but when the current in the magnet stops changing, further relaxation of the magnetic

4 Sequence of steps involved in changing the field in a superconducting magnet. **A)** The current from the power supply is zero and the supercurrent runs in the closed loop. **B)** The current from the power supply is ramped to the same level and polarity as that in the magnet. **C)** The persistent current switch is turned "on" opening the superconducting loop. **D)** The current from the power supply is changed to the new desired value. **E)** The persistent current switch is turned "off". The superconducting loop is closed, but the current from the power supply still runs. **F)** The current from the power supply is ramped to zero leaving the new value of current running in the closed superconducting loop.

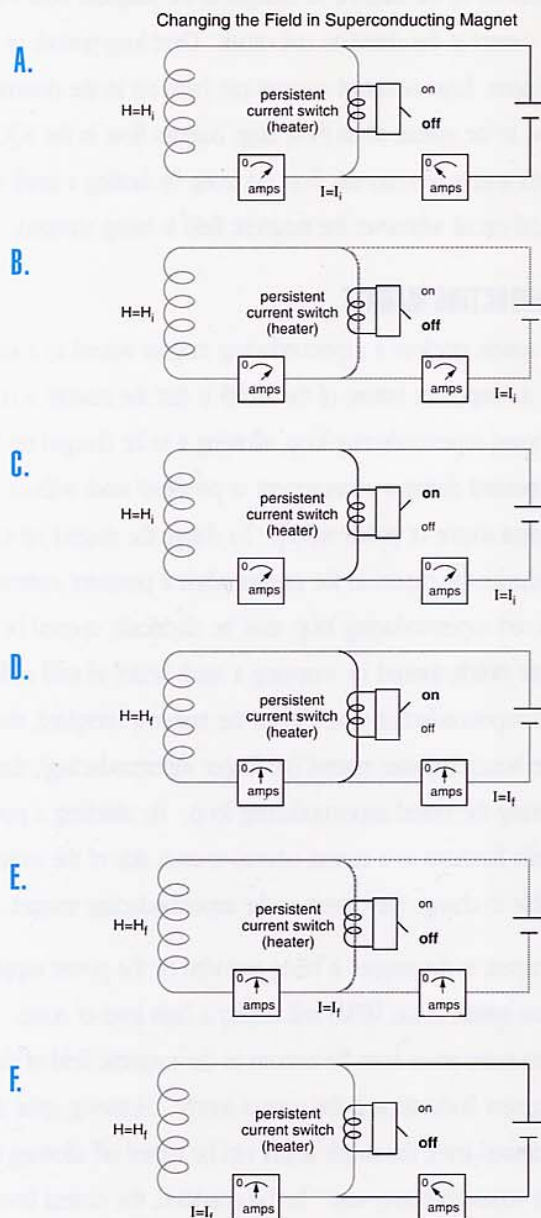

field can occur due to residual magnetic forces on the magnetic flux pinned in the magnet windings. This process is sometimes referred to as flux creep, and the MPMS has a method for changing the field (a current oscillation mode) which helps minimize these relaxation effects. The use of the "oscillate mode" is discussed below.

If the field is to be changed when the magnet is in persistent mode, it is necessary to first match the magnitude and direction of the current from the power supply to the current flowing in the magnet. The field change sequence is shown in Figure 4. If the current from the power supply is considerably different from that flowing in the magnet, there is a chance that the magnet will *quench*. When a quench occurs, a portion of the magnet becomes normal and the resistive loss in the normal segment is converted into heat. The resulting heat normally causes an even larger portion of the magnet to become normal, and the quench becomes a runaway situation in which the entire magnet eventually becomes normal. Depending on the field at which the quench occurs, and the size of the magnet, a significant quantity of helium may be lost when the magnet quenches. There are diodes located both in the MPMS console and on the magnet itself to protect the magnet from damage during a quench, but since the primary protection for the MPMS magnet is located in the control console, the MPMS magnet leads should never be disconnected from the probe when there is any persistent current stored in the magnet.

While a magnet quench is normally viewed as an abnormal and undesirable event, the MPMS actually employs a quench in an unusual application to eliminate remanent magnetic fields in the superconducting magnet. Because the magnetic field becomes trapped in the superconducting windings when the magnet is charged to a high field, discharging the magnet to zero current does not actually remove all of the magnetic field from the magnet. To purge the magnet of these trapped fields, the MPMS uses a carefully controlled quench to warm the magnet above its superconducting transition temperature for a short period of time, releasing the trapped fields.

B. SAMPLE SPACE AND TEMPERATURE CONTROL

The sample space is made from a tube with a 9 mm inside diameter, and is maintained at a low pressure with static, helium gas. At the top of the sample space is an airlock that can be evacuated and purged with clean helium gas (boil-off from the liquid helium bath in the dewar). When the purge airlock button is depressed, this evacuate/purge cycle is repeated several times. The final step of the cycling sequence brings the airlock to the low pressure maintained in the sample space. The airlock and the sample space are separated by a ball valve, which, after opening, makes the airlock a continuous part of the sample space.

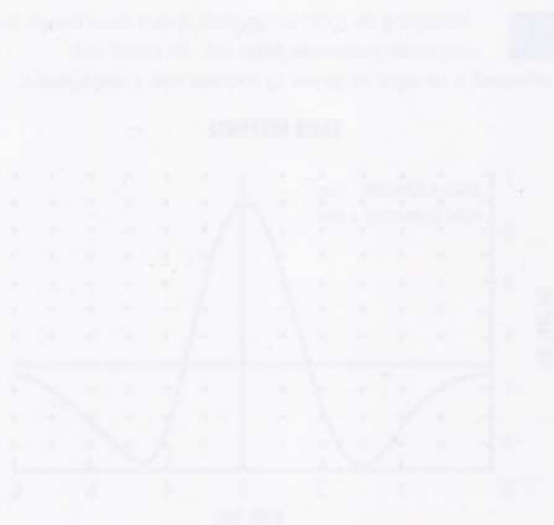

The lower portion (about 30 cm) of the sample space is lined with copper to provide a region of high thermal uniformity. Two thermometers determine the sample temperature and provide for temperature control. An extensive calibration procedure in which a standard thermometer is placed in the sample position is used to determine temperature controller constants, temperature gradients, and thermometer calibrations.

C. THE MEASUREMENT PROCEDURE

SAMPLE TRANSPORT

The sample is mounted in a sample holder that is attached to the end of a rigid sample rod. The sample rod enters the sample space through a special type of double seal (called a lip seal) designed to allow the rod to be actuated by a drive mechanism located outside of the chamber. The component containing the lip seals is clamped onto the top of the airlock with standard O-ring seals, forming the top of the sample space.

The top of the sample transport rod is attached to a stepper-motor-controlled platform which is used to drive the sample through the detection coil in a series of discrete steps. It is possible to use discrete steps because the detection coil, SQUID input coil, and connecting wires (see Figure 2) form a complete superconducting loop. A change in the sample's position causes a change in the flux within the detection coil, thereby changing the current in the superconducting circuit. Since the loop is entirely superconducting, the current does not decay as it would in a normal conductor. During the measurement the sample is stopped at a number of positions over the specified scan length, and at each stop, several readings of the SQUID voltage are collected and averaged. The complete scans can be repeated a number of times and the signals averaged to improve the signal-to-noise ratio.

The currents induced in the detection coil are ideally those associated with the movement of a point-source magnetic dipole through a second-order gradiometer detection coil. The spatial (position) dependence of the ideal signal is shown in Figure 5. To observe this signal requires that the sample be much smaller than the detection coil and the sample must be uniformly magnetized. Uniform magnetization, however, is often not encountered with high critical-current-density (J_c) superconductors. This and other kinds of nonuniform magnetization can be a problem. In addition to this, the size and shape of a sample can also require special consideration. If a sample is very long, extending well beyond the coil during a scan, its motion in the gradiometer will not be observable, since there would be no net change of the flux in the detection coil. This is the reason that a long uniform tube can be used as a sample holder. In contrast to this, when the sample is short,

5 The output of the SQUID as a magnetic dipole is moved through the second-order gradiometer pickup coil. The vertical scale corresponds to an output voltage and the horizontal scale is sample position.

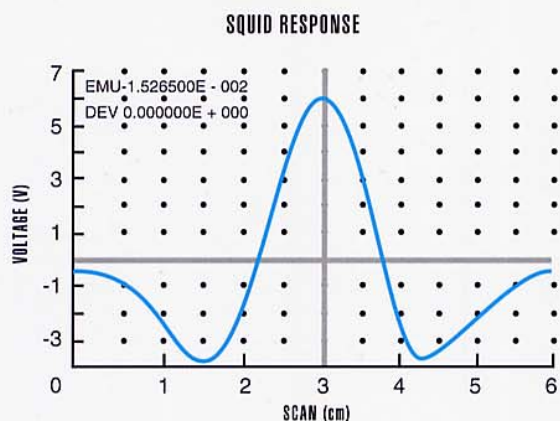

the current in the detection coil changes with sample position. This is because different amounts of flux (the local induction B) exist in each loop of the detection coil. So, it is important to realize that there is a limit on the length of a sample for which accurate measurements can be made. Some accommodation for length is made in particular computer fitting routines used to extract the value of the moment from the SQUID output. However, the safest procedure is to calibrate the MPMS with standards having a size and shape similar to the samples to be measured.

OUTPUT SIGNAL ANALYSIS

The most accurate determinations of the moment from the SQUID output signal are made using computer fits. Three different methods for analyzing the SQUID output signal are provided. All of these methods are based on the response expected for a magnetic dipole passing through a second-order gradiometer coil. The three different methods are 1) *full scan*, 2) *linear regression*, and 3) *iterative regression*. In the full scan method, the area under the SQUID voltage versus position curve is integrated, since this area is proportional to the magnetic moment. This method requires that the sample be well centered and requires fairly long scan lengths to get accurate results

The linear regression method makes a fit of the theoretical signal of a dipole moving through a second-order gradiometer to the actual SQUID output signal using a linear regression algorithm. A scan as short as 2 cm can be used, but this method requires that the sample remain well centered. When the sample is measured over a wide temperature range, the sample will change position due to changes in the length of the sample transport rod. In this case, the sample will no longer stay centered. Using software commands, the sample position can be changed within a program but this process requires a precise knowledge of how the sample position changes with temperature. Recent improvements in the MPMS control software now allow the user to select a tracking mode which keeps the sample properly centered over the normal MPMS operating range of 1.9 K to 400 K.

The iterative regression method, on the other hand, can accommodate these position offsets using additional variables within the computer program. However, there are limitations to this method, particularly when a sample has a nonuniform magnetization or the sample signal is very small. Both regression methods have fit parameters that help to accommodate deviations from ideal behavior (e.g., sample size and shape). The MPMS reports the magnetic moment data in emu (electromagnetic units). A units conversion table is given in Appendix A.

MODES OF OPERATION FOR THE MAGNET

The MPMS uses three different modes of magnet operation: *no-overshoot*, *oscillate*, and *hysteresis*. In the *no-overshoot* mode the magnetic field is changed monotonically from the initial field setting to the desired field setting. The field is ramped rapidly early in the field change, but in the final approach the field changes very slowly to avoid overshooting the target value. In the *oscillate* mode the magnetic field value alternately overshoots and undershoots the desired field with the amplitude of the overshoot and undershoot decreasing in every cycle. The purpose of the oscillate mode is to minimize the amount of magnetic flux “settling” characteristic of a field change in any superconducting magnet. High sensitivity measurements can be run more quickly (with a minimal delay time for magnet settling) after using the oscillate mode; however, oscillate mode should not be used with samples exhibiting irreversible (hysteretic) magnetic behavior. Finally, in the *hysteresis* mode the persistent-current switch is left on at all times. In this case, the magnet is **not** in persistent mode, and the current supply is constantly part of the magnet circuit. This mode is particularly useful for making rapid measurements of the magnetization as a function of field (“hysteresis loops”) of a sample. However, it can only provide good results on samples with moments of about 10^{-5} emu and larger, and therefore, is not advised for high sensitivity measurements. The liquid helium boiloff rate is also higher during hysteresis mode operation.

FURTHER INFORMATION

More information on the topics in this section can be found in the *MPMS User's Manual* and in the *Application Notes and Technical Advisories* available from Quantum Design.

D. ENGINEERING DESIGN TRADEOFFS

When designing any system that more than one person will use, and that is versatile enough for more than a single purpose, tradeoffs must be made. In this section some of the rationale for the choices made in the MPMS are discussed.

THE SAMPLE CHAMBER

The choice of sample space size is a tradeoff between possible sample sizes and desired sensitivity, since a larger sample space will result in decreased sensitivity. The MPMS can measure a magnetic moment with a range of sensitivity from about 10^{-8} emu to 2 emu in the standard configuration and can measure over 300 emu with the extended range option. Thus, measurements can be made over a range of 11 orders of magnitude for systems with the extended range option. Other methods for measuring magnetic moments, including the extraction method and the vibrating

sample magnetometer (VSM), are about two orders of magnitude less sensitive. Also, the sample space is usually smaller to obtain this sensitivity. The VSM is especially useful at the highest magnetic fields ($H > 7$ T), where the SQUID magnetometer begins to lose its sensitivity advantage.

THE DETECTION COIL

The second-order gradiometer configuration for the detection coil also represents a tradeoff. The second-order gradiometer provides a high level of noise immunity compared to first-order gradiometers. Some older SQUID magnetometers used a first-order gradiometer in combination with a superconducting shield/trap placed outside the sample space and inside the magnet. While these magnetometers had a little more overall sensitivity, operation with the superconducting shield was considerably slower, less reliable, and required a very complex design that was very expensive to build, maintain and repair.

As the gradiometer order increases, the complexity of the output signal also increases. Although there is potentially more information in such a signal, there is also an increase in the potential for errors in the analysis of the signal. In any magnetometer, it is important to consider the geometry of the sample with respect to the background. An asymmetrically mounted sample and background can lead to a distorted output signal that is far from the ideal dipole signal. To allow background subtraction, the two dipole signals (those of the sample and the background) must both have the same center. When these signals are properly positioned the magnetometer will observe a simple sum of the two signals. However, if the two signals are displaced a non-point-dipole output signal will be produced. Since all types of magnetometers are designed to measure point dipoles, this is always an important consideration. This issue is addressed in some detail in Quantum Design Application Note #1 on sample mounting. A related problem is associated with nonuniformly magnetized materials. In this case, the sample's magnetic field does not approximate a point dipole, so that the value reported by any magnetometer will be in error.

THE SUPERCONDUCTING MAGNET

In order to apply large magnetic fields (> 2 T), a superconducting magnet must be used. There are numerous considerations associated with using a superconducting magnet. For instance, after the field is changed the magnetic field will decay (relax) logarithmically in time. When making high-sensitivity measurements, it is important to allow the field to relax long enough so that the flux changes observed by the detection coil are those associated solely with the sample moving through the coil rather than the decay of the magnetic field in the magnet. To accommodate this

field relaxation, a time delay ('pause' interval) proportional to the size of the field change is advisable prior to beginning a high-sensitivity measurement.

Another important consideration when using any superconducting magnet is the remanent field. After the magnet is set to zero field by sensing the current from the current supply, there will usually be some magnetic field trapped in the magnet. This residual field is small (1 to 20 Oe) compared to the maximum field available (10000, 55000 or 70000 Oe). However, to make measurements at the lowest fields, it is important to determine the offset due to the remanent field. The MPMS has several mechanisms available for reducing the remanent field value. One way to reduce the remanent field (into the 1 to 3 Oe range) is to lower the field to zero using the oscillate mode. There are other hardware options available to reduce the field even further.

When a superconducting magnet is used to produce a wide range of magnetic fields, there is a practical limit on the spatial uniformity of the field that can be produced. Uniformity can be improved by using a larger magnet, but this slows operation, increases the physical size of the system, and increases the liquid helium boiloff. When making measurements of materials with strongly hysteretic behavior (to be discussed in Part II), it is important that the applied field at the sample not change much as the sample moves through a scan. Since the field is not perfectly uniform along its length, a longer scan length will lead to larger field deviations during a measurement. Special features of the computer fits provided with the MPMS make it possible to reduce the scan length to as little as 2 cm. For superconductors, which are the materials most sensitive to this effect, a scan length of 2.5 to 3 cm is usually adequate to avoid problems.

Any magnetometer using a superconducting magnet will be vulnerable, to some degree, to the considerations described above. In the case of the VSM, the sample motion during measurement is restricted to a few millimeters, thus reducing the chances of problems related to field uniformity. Extraction methods, on the other hand, move the sample over a few centimeters.

This section is meant to serve both as an introduction and as a reference section on magnetic units. The units of magnetism are complicated by the fact that over the years they have been defined in several different ways. There has been a great deal of reluctance for parts of the magnetics community to convert to SI units. SI stands for *Système Internationale d'Unités*, which are the official units of measure agreed upon by most nations. However, the most common system of units used among physicists, for reporting magnetic measurement results, is the Gaussian cgs system, which stands for "centimeter, gram, second." To add to the complexity, most physical properties can be reported in a variety of ways. For example, even in cgs units, the magnetization might be given in emu/g, emu/cm³, emu/mole, emu/atom, or any one of several other possibilities. Here, emu stands for *electromagnetic units*.

We must first choose a definition for the different "fields" involved. We can define three fields:

H, the applied magnetic field,

M, the magnetization, and

B, the flux density.

In cgs Gaussian units, the different fields are related by the equation

$$B = H + 4\pi M. \quad (1)$$

In our chosen definition, H is the field applied by the superconducting magnet residing outside of the sample space. This field is determined by the electric currents running in the magnet and, by our definition, it does not change when we place our sample into the magnet.

One way to look at the definition in Eq. 1 is to think of B as the net local field, H is the field from the magnet, and M is the field which changes the local field from H to B. The MPMS moves the sample through the pickup coils in order to change B within the pickup coil, and thereby changes the current flowing in the pickup coils. The amount of current induced is related to the total *magnetic moment* of the sample.

The units of magnetic moment are emu (in cgs) and A·m² (in SI units, where A is amperes and m is meters). The MPMS reports values of magnetic moment in emu. We get the magnetization M by dividing the value of the magnetic moment by volume, mass, or the number of moles in the sample.

The units for B are gauss (denoted G), in cgs units, and tesla (denoted T), in SI units. There is 1 G in 10⁻⁴ T. The units for H are oersted (denoted Oe) in cgs units, and A/m in SI units. An Oersted and a Gauss have the same dimensions, and gauss

is often used for both B and H in conversation. There is 1 Oe in $1000/4\pi$ A/m. From Eq. 1 we expect that M might also be reported in units of G. It is the volume magnetization, which is the magnetic moment of the sample divided by its volume (emu/cm^3), that can be reported in units of G. There is 1 emu/cm^3 in 1000 A/m and there is 1 emu/cm^3 in 4π G. We may also report M in units of emu/g , by dividing the magnetic moment by the mass of the sample in grams, or in emu/mole , by dividing the moment by the number of moles. Sometimes it is the magnetism associated with a certain atom in the compound that is to be measured, in which case we might report, for example, $\text{emu}/\text{Cu-atom}$ where we divided the moment measured by the number of moles of Cu atoms in the sample (similar units exist in the SI unit system). A very useful table of units and conversions, compiled by R. B. Goldfarb and F. R. Fickett of the National Institute of Standards and Technology in Boulder, Colorado, is included as Appendix A.

Two other quantities frequently used in magnetism are the magnetic susceptibility and the permeability. The susceptibility is given by $\chi = M/H$ and the permeability by $\mu = B/H$. These quantities are often used incorrectly. If an M(H) curve is not linear (a straight line), χ will depend on the value of H. Some do not consider an H-dependent χ value to be a legitimate quantity. However, whenever an H-dependent χ is to be reported, it is important that the H value associated with the χ measurement be included. The proper use of these quantities will be discussed further in later sections.

Every material exhibits some kind of magnetic behavior. However, the term “magnetic” is usually used to refer to something that will attract a piece of iron or a permanent magnet. This is a particular type of magnetism called *ferromagnetism* and is only one of the many types of magnetism. We use a magnetometer to measure the magnetization (amount of magnetism) of a sample. By studying how the magnetization changes with temperature and how it changes with the size of the magnetic field we apply to the sample, we can determine the type of magnetism and important related parameters.

There are two principal magnetic measurements:

$M(H)$ - magnetization as a function of applied magnetic field, and

$M(T)$ - magnetization as a function of temperature.

Here, H is the *applied magnetic field* which is the magnetic field applied to the sample by the superconducting magnet coil. An $M(H)$ measurement is made by fixing the temperature T and measuring M at a series of H values. An $M(T)$ measurement is made by fixing the applied field H and measuring M at a series of T values. There are other less common measurements, like magnetization as a function of time $M(t)$, that will also be discussed later. There are many different origins for the magnetic behavior observed in materials, and $M(H)$ and $M(T)$ measurements provide valuable information about the different possible types of magnetic behavior.

A. PARAMAGNETISM

INTRODUCTION

Probably the simplest type of magnetic behavior is known as *paramagnetism*. Shown in Figure 6 is a plot of $M(H)$ for a typical paramagnet at a fixed temperature. The key features are that 1) the curve is linear, 2) the line intersects zero, and 3) the magnetization is *reversible*. Reversible means that the same curve is followed when going up in field as when going back down in field. When the $M(H)$ curve is linear, the *magnetic susceptibility* χ , which is given by $\chi = M/H$, is often an important property.

A. PARAMAGNETISM

6 Magnetization (M) as function of applied magnetic field (H) for a paramagnetic compound, LaCuO_3 , at $T=100\text{ K}$. The squares are data collected on increasing field, the x -symbols are data collected on decreasing field. The curve is linear in H and reversible (i.e., the same curve is followed on increasing and decreasing field.)

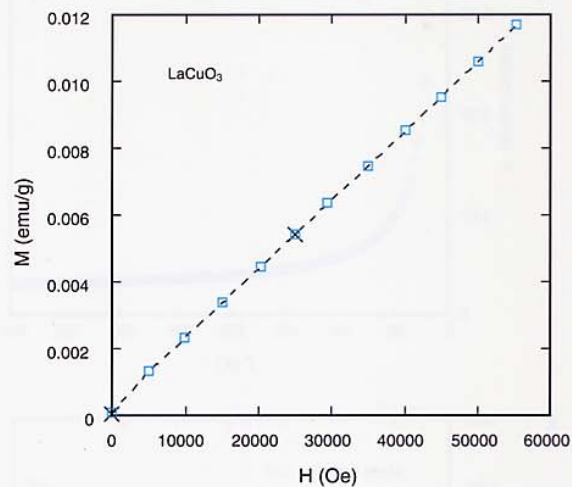

A. PARAMAGNETISM

7

A) Magnetic susceptibility (χ) as a function of temperature (T) for a hypothetical material with nearly ideal Curie paramagnetic behavior having a mole of $S=1/2$ atoms. B) The inverse of χ (in mole/emu) as a function of T . The slope of the curve is proportional to $1/C$.

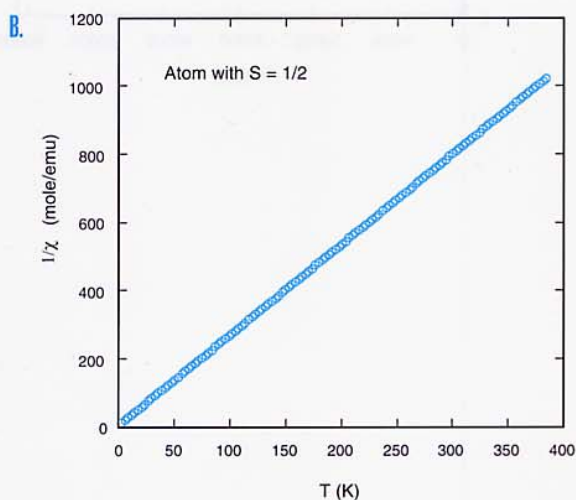
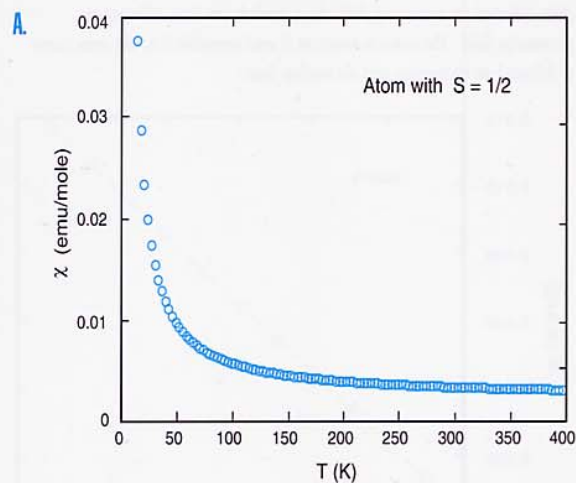

Curie-Type Paramagnetism

Paramagnetism can have many different origins. Since the $M(H)$ curves are linear, two features are often used to determine the origin of the paramagnetism: the magnitude of χ and the temperature dependence of the susceptibility $\chi(T)$. Shown in Figure 7a is a plot of $\chi(T)$ for a Curie-type paramagnet, which is a type of magnetism resulting from the presence of atoms with unpaired electrons. Curie-type paramagnetism has a particular temperature dependence $\chi(T) = C/T$, where C is a constant. A plot of $1/\chi$ versus T , as shown in Figure 7b, is very useful for characterizing Curie paramagnets. The slope of the curve is equal to $1/C$ and the Curie constant is given as

$$C = b \mu_{\text{eff}}^2 N,$$

where μ_{eff} is known as the *effective magnetic moment*, b is a universal constant, and N is the concentration of magnetic atoms with that moment. Thus, the constant C can be used to determine the *product* of the effective magnetic moment of an atom and the number of magnetic atoms present. If the number of magnetic atoms is known (from a mass measurement, for example), it is then possible to determine μ_{eff} associated with the magnetic atom.

UNITS

When $M(H)$ is linear and reversible it is possible to define the magnetic susceptibility as $\chi = M/H$. The MPMS reports the magnetic moment m in units of emu, a cgs unit. If this is divided by the volume (in cm^3) one will have the volume magnetization M (in emu/cm^3). Dividing this M by the applied field H (in Oe) gives the volume susceptibility, which is dimensionless, but often expressed as emu/cm^3 or $\text{emu}/(\text{cm}^3 \text{ Oe})$. Similarly dividing m by the mass in grams (g) gives the mass magnetization M_g (or σ). Dividing M_g by H in Oe gives the mass susceptibility, which is expressed as emu/g . Dividing m by the number of moles gives the molar magnetization M_m in emu/mole . Dividing this by H in Oe gives the molar susceptibility, which is also expressed as emu/mole . These can be converted to SI units using the table in Appendix A.

EXAMPLES AND ADVANCED TOPICS

Curie Paramagnetism

To determine the μ_{eff} for a Curie-paramagnetic sample will first require calculating the molar susceptibility values (often denoted χ_m). Next $1/\chi_m$ is plotted as a function of temperature, like the data shown in Figure 7b. If the $M(H)$ curves are linear, the χ_m value at any magnetic field can be used. For a Curie paramagnet the $1/\chi_m$ curve will intercept zero and have a slope $1/C_m$, where C_m is the molar Curie

units of emu-K/mole. To get p_{eff} from C_m , we use the complete formula

$$C_m = (N p_{\text{eff}}^2) / 3 k,$$

where N is Avogadro's number (6.02×10^{23}) and k is Boltzmann's constant (1.38×10^{-16} erg/K). Rearranging this gives

$$p_{\text{eff}} = (3 k C_m / N)^{1/2},$$

with p_{eff} in units of erg/Oe. The effective moment is usually reported in units of Bohr magnetons (denoted μ_B). Dividing by 0.927×10^{-20} (erg/Oe)/ μ_B will give p_{eff} in units of μ_B . A shortcut to getting p_{eff} (in μ_B) from C_m (in emu K/mole) is to use

$$p_{\text{eff}} = 2.82 C_m^{1/2}. \quad (2)$$

The χ data in Figure 7b are in units of emu/mole. The slope of this curve is 2.66 and since the slope equals $1/C_m$, this gives $C_m = 0.376$. Using Eq. 2 we find that $p_{\text{eff}} = 1.73 \mu_B$, which is the effective moment associated with spin $s = 1/2$ atoms like those of Cu^{2+} .



OTHER TYPES OF PARAMAGNETISM

Curie-Weiss Paramagnetism

For a Curie-type paramagnet, there is a force that tries to align the magnetic moments on atoms with the magnetic field ($\mathbf{p}_{\text{eff}} \cdot \mathbf{H}$). The $1/T$ (or Curie) temperature dependence is a result of a competition between the force aligning the moments parallel to the field and the tendency for heat to disrupt the alignment. As the temperature increases, the associated increase in heat reduces the relative effect of the field.

What is different about a *Curie-Weiss* paramagnet is that, in addition to the interaction with the applied magnetic field, there is an interaction between the magnetic moments on different atoms. This interaction between moments (exchange interaction) can help align adjacent moments in the same direction or it can help align neighboring moments in opposite directions.

The Curie-Weiss susceptibility is given by

$$\chi_{\text{CW}} = C/(T - \theta), \quad (3)$$

where θ is called the *Curie-Weiss temperature*. The Curie-Weiss θ is related to the strength of the interaction between moments, and its sign depends on whether the interaction helps align adjacent moments in the same direction or opposite one another. Using the definition in Eq. 3, for $\theta > 0$ the interaction helps to align adjacent moments in the same direction, and for $\theta < 0$ the interaction helps to align adjacent moments opposite each other. Other terminology, which will become

B. DIAMAGNETISM

8

The inverse of χ as a function of T for systems exhibiting Curie ($\chi = C/T$) and Curie-Weiss behavior ($\chi = C/(T-\theta)$). When $\theta > 0$ the interaction between moments helps to align neighboring moments in the same direction and when $\theta < 0$ moments are aligned in opposite directions. When $\theta = 0$ the moments act completely independent of one another.

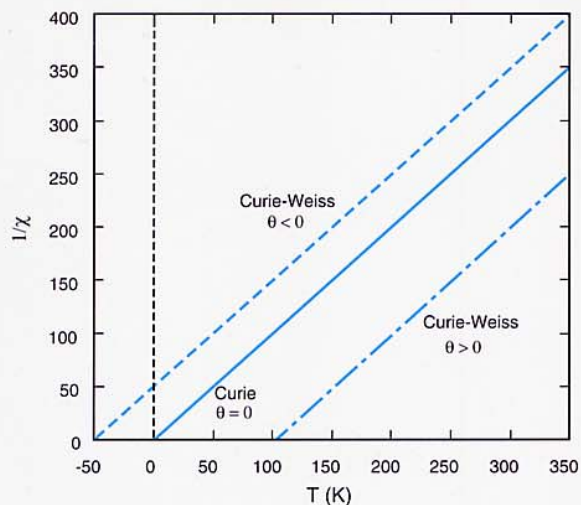

clearer in later sections, is that for $\theta > 0$ there is a net *ferromagnetic interaction* between moments and for $\theta < 0$, there is a net *antiferromagnetic interaction* between moments.

The characteristic plot for Curie behavior was the $1/\chi$ versus T plot, and the same is true for Curie-Weiss behavior. But as shown in Figure 8, instead of a straight line through zero, as in Figure 7b, we get an x-axis intercept at a positive or negative θ . In the case of the ferromagnetic θ ($\theta > 0$), it can be seen that Eq. 3 diverges (goes to infinity) at $T = \theta$. This is the approximate location of a ferromagnetic transition, also known as the *Curie temperature* (denoted T_C). For an antiferromagnetic θ ($\theta < 0$), Eq. 3 will not diverge at $T = \theta$. However, the system may now have an antiferromagnetic transition, known as a Néel transition (denoted T_N), near $T = |\theta|$.

Pauli Paramagnetism and Van Vleck Paramagnetism

Pauli paramagnetism is observed in metals and is due to the fact that conduction electrons have magnetic moments that can be aligned with an applied field. The key characteristics of Pauli paramagnetism are that the χ value is nearly independent of temperature and in most cases it has a very small value.

Van Vleck paramagnetism is another type of paramagnetism that is also nearly independent of temperature and usually has a small value. Van Vleck paramagnetism is associated with thermal excitations to low-lying states.

Combinations

Often the temperature dependence of the paramagnetism does not follow any particular dependence. In these cases it can be useful to see if the behavior can be fit by an equation that combines a temperature independent part and a Curie, or Curie-Weiss, part. Antiferromagnets also have $M(H)$ curves like paramagnets, even below T_N . The $M(T)$ behavior is distinctive for well-behaved antiferromagnets, and is confusing in other cases. Antiferromagnetism will be discussed in more detail below.

There are also a variety of much more complicated magnetic behaviors that are active areas of research and are not easily identified by an $M(T)$ curve. These include heavy-fermion systems, mixed-valence systems, spin-density-wave systems, spin glass systems, as well as others.

B. DIAMAGNETISM

When an $M(H)$ plot is linear and reversible but has a negative slope, we describe the magnetic behavior as diamagnetism. This means that χ is negative. In most cases a diamagnetic contribution to the magnetism arises from paired electrons and the value of this contribution is usually extremely small. Tables of the contributions

due to certain atoms and atom combinations, usually called *Pascal's Constant tables*, are used for approximating these contributions. The other important type of diamagnetism is superconductivity, which can have the largest possible value of diamagnetism. This will be discussed at length below.

There is an interesting observation one can make about diamagnets: they are repelled by a magnetic field. On the other hand, a paramagnet is attracted into a magnetic field. A simple picture for this is to think of the magnetic field to be composed of lines of magnetic field. The density of lines at any point is proportional to the field B . A diamagnet will push field lines out while a paramagnet will pull them in. Thus, for a diamagnet $B < H$ inside the sample and for a paramagnet $B > H$ inside the sample.

C. FERROMAGNETISM

INTRODUCTION

Ferromagnetism is a very important type of magnetism. Ferromagnets, and the related ferrimagnets, are the materials we usually call magnets - they are attracted to a piece of iron or a permanent magnet. The strongest type of magnetism found in materials is ferromagnetism. Ferromagnets have very distinctive $M(H)$ and $M(T)$ curves. Figure 9 shows a typical $M(H)$ curve for a ferromagnet at a fixed temperature. The key features are that the curve is *not* linear and the behavior is *not* reversible. The lack of reversibility is often called *magnetic hysteresis*. Figure 9 shows that as H is increased the magnetization gradually reaches a maximum value known as the *saturation magnetization*, which is usually denoted M_s . The saturation magnetization is an important property of a ferromagnet that is the same for any piece of a particular compound (it is an *intrinsic property*) no matter what the material's processing history has been.

As H is reduced back to zero from saturation, we can see in Figure 9, that a different curve is followed on the way down and that M does not go to zero when H returns to zero. The value of the *magnetization* when H is returned to zero is called the *remanent magnetization*, denoted M_{rem} . The remanent magnetization is often confused with the saturation magnetization, but they are very different properties. Whereas the saturation magnetization is an intrinsic property of a compound, the remanent magnetization depends on the way a sample of the material has been prepared and treated (its history). A large remanent magnetization is desirable for applications like magnetic recording, whereas a small remanent magnetization is desirable for applications like magnetic transformer cores. Materials with large remanent magnetizations are called *hard ferromagnets*, and those with small remanent magnetizations are called *soft ferromagnets*.



9 Magnetization as a function of field at $T < T_C$, after cooling the sample from above T_C . Identified are the initial magnetization curve (or virgin curve), the saturation magnetization (M_s), the remanent magnetization (M_{rem}), and the coercive field (H_c).

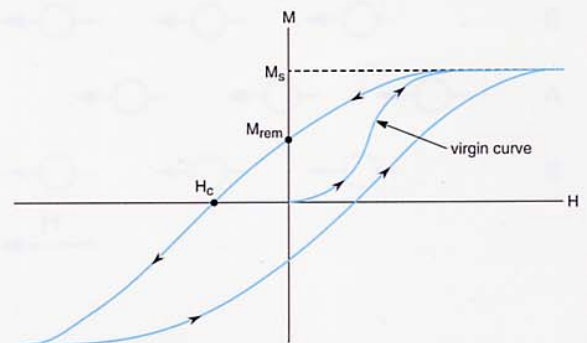

C. FERROMAGNETISM

10

Above the Curie temperature (T_C) a ferromagnet is paramagnetic exhibiting Curie-Weiss behavior ($\chi = C/(T-\theta)$) with $\theta > 0$. Below T_C , χ is no longer a useful parameter since χ is both field and history dependent. Instead, the saturation magnetization M_s is an important intrinsic property.

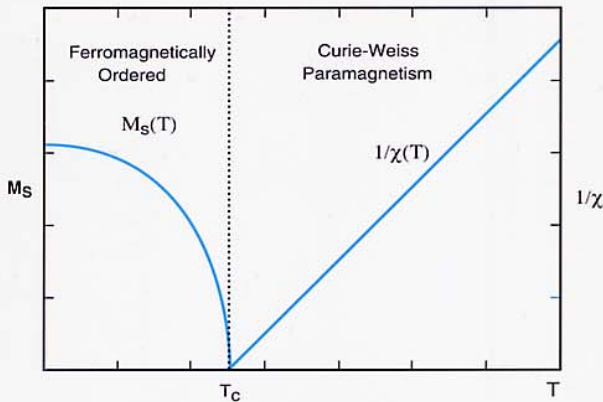

11

Schematic diagram showing how the atomic moments in a ferromagnet are locked together and aligned in the same direction below T_C .

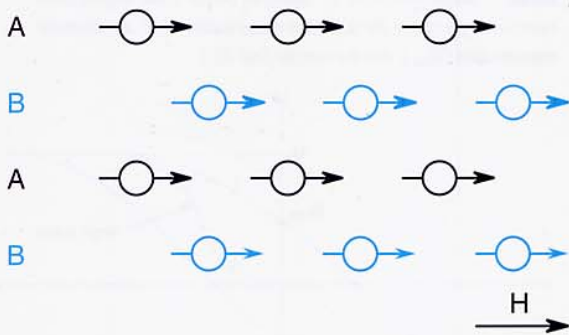

The magnetization of a ferromagnet does not return to zero by reducing H to zero. However, by applying a sufficiently large magnetic field in the opposite direction, the magnetization can be returned to zero. The magnetic field required to return the magnetization to zero is called the *coercive field*, usually denoted H_C . The coercive field is not an intrinsic property and the value of H_C has an additional dependence on the rate of change of the magnetic field dH/dt . The size of the coercive field determines how useful the material is for various applications. Although H_C is related to the remanent magnetization (i.e., if M_{rem} were zero, H_C would also be zero), it is a different property.

So far the description of a ferromagnet has been an operational one. A major distinction between ferromagnets and paramagnets is that the ferromagnetic state is a state of *long range order*. This long range order sets in at a phase transition which occurs at the Curie temperature. The Curie temperature is close to the same point where a $1/\chi$ versus T plot will extrapolate to zero for a Curie-Weiss paramagnet that becomes ferromagnetic. An example is shown in Figure 10 where Curie-Weiss paramagnetic behavior ($\chi = C/(T-\theta)$) with $\theta > 0$ is observed above the transition, while below T_C the system is ferromagnetically ordered. Below T_C , χ is no longer a useful parameter, since χ is both field and history dependent, and instead, it is the saturation magnetization M_s that is an important intrinsic property.

In a ferromagnet below T_C , the individual magnetic moments of the atoms are all lined up in the same direction and essentially locked together as shown schematically in Figure 11. Instead of the magnetic moments acting individually, they act together like one very large magnetic moment. The term "long range order" means that if we know the orientation of one moment at a particular position, we can determine the orientation of any other moment a long distance away. For a ferromagnet, all of the moments within a domain are aligned in the same direction. On the other hand, for a paramagnet the orientation of any moment is random and even though there is a higher probability for a moment to align with the magnetic field, each moment acts nearly independently of the others.

UNITS

The units for magnetization and applied magnetic field are the same for ferromagnets as they are for all types of magnetic systems. It is important to remember that M_{rem} and M_s have values of magnetization, while H_C is a value of the applied magnetic field.

EXAMPLES AND ADVANCED TOPICS

History Dependence

Ferromagnets usually exhibit some amount of irreversibility (or hysteresis) in their $M(H)$ behavior. This irreversibility in the $M(H)$ curves is a part of a more general type of behavior often referred to as *history dependent* behavior. Here, history dependent means that the value of the magnetic moment observed is dependent on the sequence of magnetic field changes and temperature changes that were involved in getting the sample to the condition in which it was measured.

In addition to the hysteresis in $M(H)$ curves at fixed temperature, $M(T)$ behavior can also show a dependence on the magnetic field history if M is not saturated on every half-cycle of a $M(H)$ loop.

One way of determining if irreversibility exists is to do a *zero-field-cooled/field-cooled* (ZFC/FC) set of measurements. This is done by cooling the sample to the lowest measurement temperature in $H = 0$. Once stabilized, a magnetic field is applied and the moment is measured as a function of temperature up to the highest desired temperature. This is the ZFC part. Next the sample is cooled in this same field to the lowest temperature and again measured as a function of temperature. This FC part can also be done by collecting data as the sample is cooled, however, most cryogenic systems are more time efficient when collecting on warming. At least in the case of superconductors, the FC data should be collected on cooling, not on warming. This ZFC/FC method is very useful for determining the temperature range over which systems are irreversible. Results of a ZFC/FC measurement are shown in Figure 12.

Another important result of irreversibility in ferromagnets is that the shape of an $M(H)$ curve will change unless saturation is attained on every half cycle of a hysteresis loop. If a magnetic field below saturation is used, a different $M(H)$ curve will be traced. These other curves are usually called *minor loops*. Running a magnetic material through a series of minor loops of decreasing size (smaller and smaller peak values of H) is a method for “demagnetizing” a ferromagnet. Demagnetization can be a misleading term because the sample is still ferromagnetic. When demagnetized, a ferromagnet consists of many small domains within which magnetic moments point in the same direction. Adjacent domains however, have their magnetization pointing in different directions. In this way, the magnetic field lines can close inside the sample and the remanent magnetization is zero. Domains are discussed in the next section.

12

Magnetization as a function of temperature for the cases where a) the sample is first cooled in $H = 0$, a field turned on, and then data collected on warming (ZFC) and, b) when data are collected as the sample is cooled in the same field (FC).

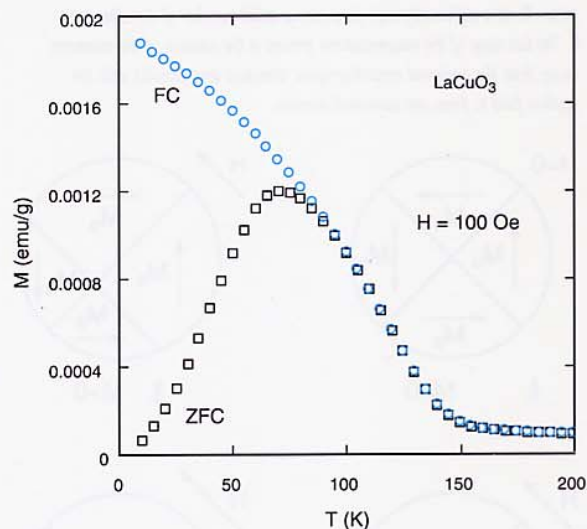

13

The magnetization process for a ferromagnetic sample that was cooled from above its T_C . **A.** In $H = 0$ the magnetic domains form a closed loop with the moments aligned along preferred crystallographic directions. Within each domain the magnetization is saturated. **B.** As H is applied the domain walls move to allow the domains aligned with the field to grow. **C.** At a sufficiently high field only a small number of domains exist. **D.** The last stage of the magnetization process is the rotation of the moments away from the preferred crystallographic direction and parallel with the applied field to form one saturated domain.

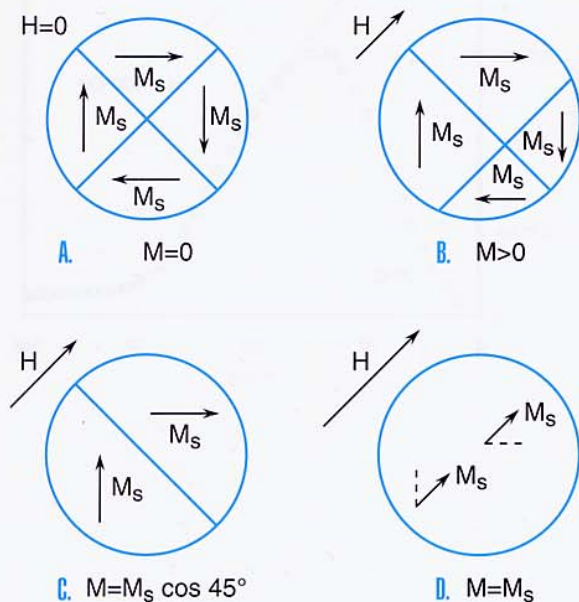

Magnetic Domains

When a ferromagnet is cooled from a temperature above its Curie temperature in $H = 0$, it will usually show very little evidence of having a large magnetization value. This is due to *domain* formation. Instead of all the magnetic moments in the sample lining up in the same direction in one single domain, the lower energy configuration is for the sample to be divided up into several or many magnetic domains. Within a domain, all of the moments are aligned in the same direction (the magnetization is saturated within a domain). It is important to note that the magnetic domains are not the same as crystallographic domains—the magnetic domains cannot be seen without magnetic imaging techniques. In the border region between different magnetic domains, the direction of the magnetization changes. This border region is called the *domain wall*. It is the way that domain walls move that causes much of the irreversibility in ferromagnets.

When a magnetic field is applied to a sample that has been cooled in $H = 0$ from above T_C , the sample will initially seem to be nonmagnetic. As a magnetic field is initially applied, the $M(H)$ behavior looks like the initial curve identified in Figure 9. This is called the “virgin curve” and the behavior associated with this curve is shown in Figure 13. Initially, the domains are directed so that the spontaneous magnetic fields form a closed magnetic loop. When a magnetic field is applied, more of the moments start to align with the field. This does not happen randomly within all domains, but rather the domains with a component directed along the field direction preferentially grow in size. In Figure 13 this is pictured as the domain wall moving. This selective domain growth continues until the whole sample is one domain. Even though the moments in a domain are parallel to each other, they still may not be aligned with the magnetic field but along some preferred crystallographic direction. This is due to *magnetic anisotropy*, which is a topic for a separate discussion. To reach full saturation requires that the moments turn from their preferred crystallographic direction to be parallel to the magnetic field.

As the field is reduced from saturation, the moments will first return to the preferred crystallographic direction. As the field is decreased further, the domain walls will reform (or nucleate) and try to move. The domain wall motion can, however, be strongly impeded as in the case of hard ferromagnets. This impedance to domain wall motion is caused by domain wall *pinning*. Domain walls can get stuck at various defects, like grain boundaries and inclusions, producing the characteristics of remanence and coercivity.

Magnetic Recording and Transformer Coils

The area within an $M(H)$ loop is the energy dissipated on cycling that sample through the loop. The magnetic cores of ac powerline transformers, which are cycled through an $M(H)$ loop at 50 to 60 times per second, is an example in which a soft ferromagnet is very useful. A large mutual inductance is possible with a minimum of *hysteretic loss*.

An important application of hard ferromagnetic materials is their use in magnetic recording media. Two states are required to store binary data. The recording head is a small magnetic pickup coil that can discern regions having either of the two different directions of magnetization. The head is also used to write these regions. To write, the coil applies a magnetic field, larger than H_c , to the recording media in one or the other direction for a short time. A patch of magnetic material is thereby "switched" into a particular direction. The coercive field (H_c) determines the size of the field necessary to switch the field in that region. On the other hand it is the remanent magnetization (M_{rem}) of the magnetic media that determines how large a magnetization is available for the head to read.

D. ANTIFERROMAGNETISM AND FERRIMAGNETISM

ANTIFERROMAGNETISM

The term *antiferromagnet* often produces considerable confusion. Some people may think that an antiferromagnet is a ferromagnet but with the magnetic moments all lined up opposed to the applied field direction. However, this kind of behavior has never been observed. In an antiferromagnet the magnetic moments line up so that adjacent moments are aligned in opposite directions to each other (see Figure 14). Instead of the enormous combined moments associated with ferromagnets, the moments on neighboring atoms cancel each other, resulting in relatively small values of M . The $M(H)$ behavior is more characteristic of a paramagnet; however, the origin of the $M(H)$ behavior in antiferromagnets is quite different from that of Curie paramagnets, since the antiferromagnetic state is a long range ordered state. The moments are locked together but in the alternating configuration shown in Figure 14.

The temperature dependence of an antiferromagnet is shown in Figure 15. The phase transition to the antiferromagnetic state is known as a Néel transition and occurs at a temperature usually denoted T_N . Above T_N an antiferromagnet is often paramagnetic exhibiting Curie-Weiss behavior ($\chi = C/(T - \theta)$) with $\theta < 0$. Since $M(H)$ curves are linear below T_N , χ remains a useful property.

D. ANTIFERROMAGNETISM AND FERRIMAGNETISM

14 Schematic diagram showing how the atomic moments in an antiferromagnet are locked together and aligned so that adjacent moments have spins in opposite directions. Above T_N , in the paramagnetic state, the moments behave nearly independently of one another.

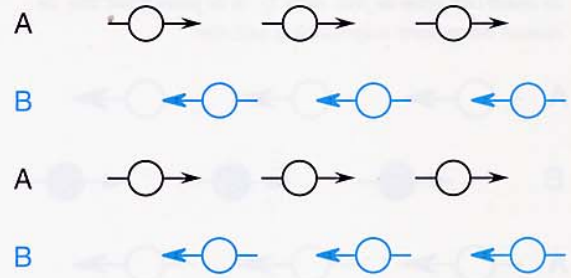

15 Magnetic susceptibility and inverse susceptibility as a function of temperature for an antiferromagnet. Above the Néel temperature (T_N) a antiferromagnet often resembles a paramagnet exhibiting Curie-Weiss behavior ($\chi = C/(T - \theta)$) with $\theta < 0$.

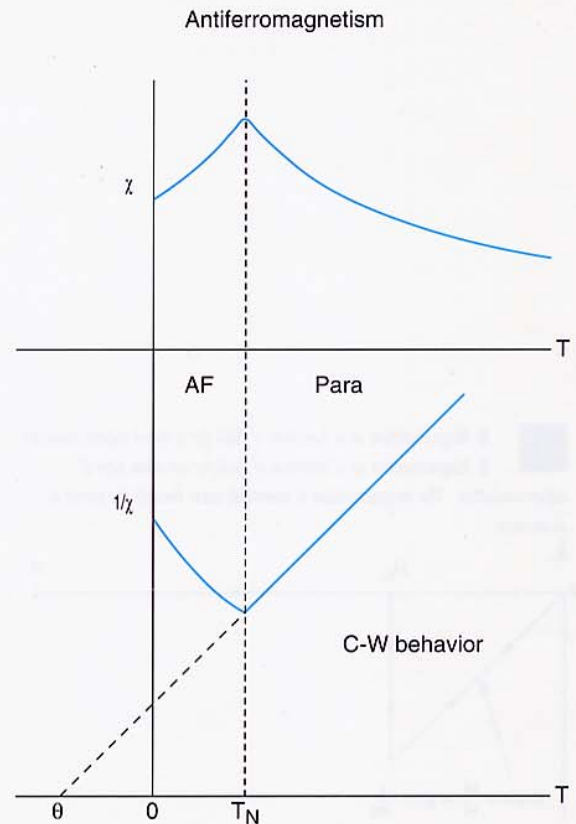

E. SUPERCONDUCTIVITY

16 Schematic diagram showing how the atomic moments in a ferrimagnet are locked together and aligned so that adjacent moments have spins in opposite directions. The adjacent moments are of different size. The larger moments usually line up with the applied field and the smaller ones oppose the field. Above T_C , in the paramagnetic state, the moments behave nearly independently of each other.

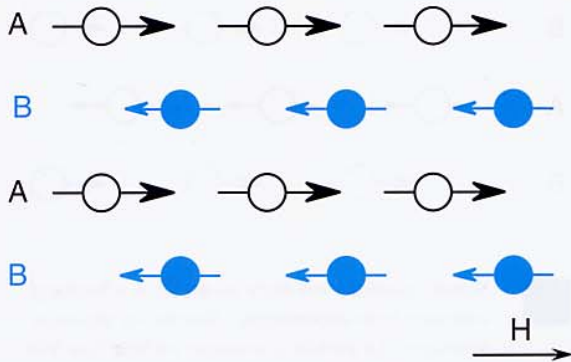

17 A) Magnetization as a function of field for a type-I superconductor. B) Magnetization as a function of field for an ideal type-II superconductor. The magnetization is reversible even though the curve is nonlinear.

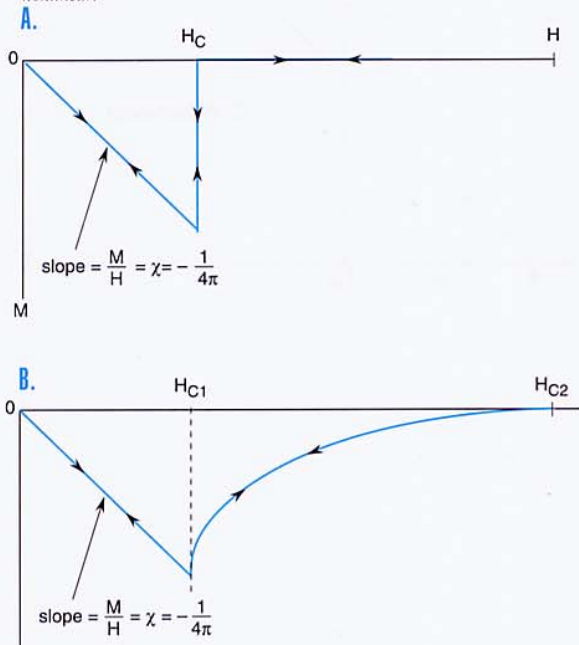

FERRIMAGNETISM

Ferrimagnets are often associated with ferromagnets because their $M(H)$ and $M(T)$ behavior is nearly identical to that of ferromagnets. However, at the atomic level ferrimagnets are more similar to antiferromagnetics because the magnetic moments of the atoms in ferrimagnets are antiferromagnetically coupled; i.e., adjacent magnetic moments are locked in opposite directions. What makes ferrimagnets different from antiferromagnets is that the adjacent moments have different magnitudes. The larger of the two moments tends to align with the applied magnetic field while the smaller moment aligns opposite to the field direction (see Figure 16). The result is that the different moments add up to produce a large net moment aligned with the magnetic field. Some of the most useful materials for making permanent magnets are ferrimagnets. Many of these materials are non-electrically conducting ceramics.

UNITS

Antiferromagnets behave essentially like paramagnets. On the other hand, ferrimagnets behave essentially like ferromagnets, having the same types of irreversibility possible and the same parameters (H_C , M_{rem} , and M_S) used to describe their behavior.

E. SUPERCONDUCTIVITY

INTRODUCTION

Another very important type of magnetism is associated with superconductivity. The magnetic properties of superconductors are unique and very complex. Figure 17a is a plot of $M(H)$ at a fixed temperature for a type-I superconductor in the superconducting state. Currents near the surface of a type-I superconductor completely screen the inside of the sample, from the applied magnetic field, up to a field called the *critical field* (denoted H_C). Screening of the field means that none of the applied magnetic field gets into the sample, and the superconductor acts like a magnetic mirror (with $B = 0$ inside the superconductor). Up to H_C , the $M(H)$ curve is linear having the largest negative slope possible. This volume magnetic susceptibility is that of a perfect diamagnet ($\chi = -1/4\pi$ in cgs units), which is an enormous value compared to most other diamagnets.

An $M(H)$ curve for an ideal type-II superconductor is shown in Figure 17b. Up to an applied field known as the lower critical field H_{C1} , a type-II superconductor behaves like a type-I superconductor. However, when the applied magnetic field H exceeds H_{C1} the magnetization begins to decrease in magnitude due to the penetration of the magnetic field into the material in the form of *flux vortices*.

The magnetization will continue to decrease up to a magnetic field value called the *upper critical field* (denoted H_{c2}). At H_{c2} and higher fields the superconductivity is suppressed and the system becomes normal (non-superconducting). The curve shown in Figure 17b is the ideal type-II superconductor $M(H)$ curve and this curve is reversible even though it is non-linear above H_{c1} . It is interesting to note that this ideal superconductor would be useless for most applications, and, in fact, no supercurrent could flow above H_{c1} in such a superconductor. For it to be useful in practical applications we must modify the superconductor in ways such that the $M(H)$ curve of the superconductor becomes irreversible (hysteretic). This can be done by introducing defects into the material, usually through an appropriate choice of preparation and processing conditions. These defects serve to pin the magnetic field lines, thereby restricting their motion. It is the motion of the field lines that usually limits the current density above H_{c1} .

Introducing defects into an ideal superconductor changes the $M(H)$ curve from that of Figure 17b to one like that of Figure 18 which shows little evidence of H_{c1} ; furthermore, the $M(H)$ curve is definitely neither linear nor reversible. Now it is possible for a supercurrent to flow above H_{c1} , and the amount of supercurrent that can flow can be determined from the value of the magnetization. An important quantity in such superconductors is the critical current density (denoted J_c), and it is a remarkable result that a magnetic measurement can be used to determine how much electrical supercurrent (a transport property) can be carried by the superconductor. The relation between the magnetization M and J_c is called the *Bean Critical State Model* and is given by

$$J_c = s M / d,$$

where d is the sample width or diameter and the constant s is a shape dependent constant having a value $s = 10/\pi$ for an infinite rectangular slab sample and $s = 15/\pi$ for a cylindrical sample. (This equation is for units of J_c in A/cm^2 , M in G, and d in cm.)

Another important property of a superconductor is its superconducting transition temperature (usually denoted T_c for critical temperature). This is the temperature at which the sample goes from the superconducting state to normal state upon warming. T_c usually decreases as H is increased. It is common to measure the *Meissner effect* in order to determine T_c . When an *ideal* superconductor is cooled through its superconducting transition with a very small field applied to the sample (field-cooled (FC) measurement), the magnetic field will be completely expelled from the inside of the superconductor at T_c . The expulsion of the field at T_c is the Meissner effect and it is possible to determine T_c by measuring $M(T)$ as the point at



18

Magnetization as a function of field for a superconductor exhibiting irreversible magnetic behavior associated with flux pinning.

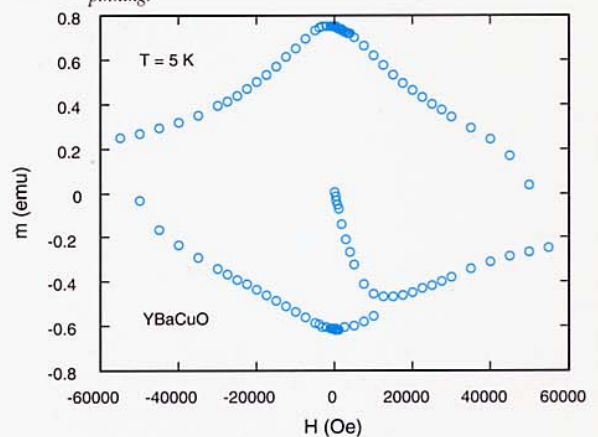

19

Magnetization as a function of temperature for the high temperature superconductor LaSrCuO . Both zero-field-cooled and field-cooled measurements are presented.

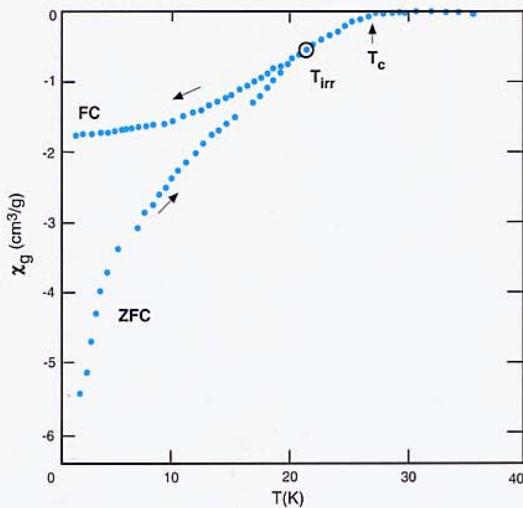

which there is a drop in M (remembering that M is negative). A plot of $M(T)$ for a high temperature superconductor is shown in Figure 19.

It is not uncommon to see a different measurement, often called *magnetic shielding* or *screening*, mistakenly called the Meissner effect. Magnetic shielding is measured by first cooling the sample to a low temperature below T_c , then turning on a magnetic field (which is also called a zero-field-cooled (ZFC) measurement). The changing magnetic field induces currents that flow as long as the sample is superconducting. The Meissner measurement and the shielding measurement both are often mistakenly used as a measure of the amount (quantity) of superconducting material in a sample. A *100% Meissner fraction*, which corresponds to a $\chi = -1/4\pi$ susceptibility value, can be used as a legitimate measure of a completely superconducting sample. However, any value of the Meissner fraction less than 100% could simply mean that there is flux pinning in the sample. The shielding measurement has other potential problems. For example, if a sample has only a thin superconducting skin and a non-superconducting center, it could conceivably produce a $\chi = -1/4\pi$ susceptibility value, since the skin could screen the whole interior of the sample to compensate the applied field H ($B = 0$ inside the sample).

UNITS

It is important to realize that the superconducting shielding results from the screening of a **volume**. The magnetization value will depend on the size of the applied field; therefore, it is the volume susceptibility χ which is important. In cgs units, perfect diamagnetism, or complete screening, has a value of $\chi = (-1/4\pi)$ emu/cm³. Another way of viewing this is to realize that $B = 0$ in Eq. (1), requires that $-4\pi M = H$, and therefore $M/H = -1/4\pi$. In SI units, $\chi = -1$.

The critical current density (J_c) is a current per unit cross sectional area. The cgs units are A/cm² and the SI units are A/m².

EXAMPLES AND ADVANCED TOPICS

Irreversibility Line

The region in the phase diagram between H_{c1} and H_{c2} in a type II superconductor is called either the *Abrikosov* or the *flux-vortex phase*. As discussed above, at a fixed temperature and for $H > H_{c1}$, the magnitude of M decreases as H increases. The decrease in M is due to the fact that for $H > H_{c1}$, $B \neq 0$ inside the sample, and some of the magnetic field actually penetrates into the superconductor. However, the magnetic field inside the superconductor is not distributed uniformly as it would be in most other types of material. The field that penetrates into a superconductor is *quantized* into single *quanta* of magnetic flux. A single quantum of magnetic flux

(denoted ϕ_0) has a value $\phi_0 = 2.07 \times 10^{-7}$ G-cm² in cgs units. There is a supercurrent loop associated with each magnetic flux quantum and together this comprises an entity called a *flux vortex*.

Flux vortices can be thought of as discrete lines of B. When an electrical transport current is applied to a superconductor containing flux vortices, the vortices experience a force, called the Lorentz force, which acts perpendicular to the current. If the vortices are moved by the Lorentz force, however, they generate a voltage parallel to the current that in turn produces resistive losses. To keep a supercurrent flowing requires zero resistance, therefore the flux vortices must be kept from moving. Defects in the sample can pin the vortices and thereby allow large supercurrents (large J_c values) to flow.

It was a surprise to many when it was observed that for high temperature superconductors the magnetic phase diagram between H_{c1} and H_{c2} was split into two regions and separated by a new phase boundary that is commonly referred to as the *irreversibility line* (IRL). On the upper side of the IRL below H_{c2} there is no pinning, the magnetic behavior is reversible, and no bulk supercurrents can flow. For temperatures and fields below the IRL, the magnetic behavior is irreversible and bulk supercurrents can flow. One way of measuring the IRL is to use the zero-field-cooled/field-cooled (ZFC/FC) method described in the section on ferromagnets. Below the IRL the irreversibility results in two different curves for ZFC and FC, while above the IRL there is only one value of M at a given H and T, and thus the ZFC and FC curves are superimposed as shown in Figure 19. The IRL is an important property that sets the limits on the range where a superconductor can be used in most applications. A plot showing the relationship between the IRL and the critical fields is presented in Figure 20.

Minor Loops

When trying to measure irreversible magnetic properties in a sample, it is important to be able to control the sample's field history. Determining J_c using a magnetic measurement requires that the critical state be established in the sample. To establish the critical state the field should be changed monotonically and then should not change at all during the measurement scan.

If the length of an MPMS measuring scan is too long, the sample will experience a significant change in the value of the magnetic field during the scan. This occurs because the field in a superconducting solenoid changes with position. Over a long scan length, the sample experiences non-monotonic field variations, and, in fact, the field at the sample oscillates as the sample moves up and down. The result is that the critical state in the sample is reduced or destroyed (the sample is effectively



20

A magnetic phase diagram for the high temperature superconductor $\text{YBa}_2\text{Cu}_3\text{O}_7$. The irreversibility line separates a region (lower H and T) of finite critical current density J_c from one with $J_c = 0$.

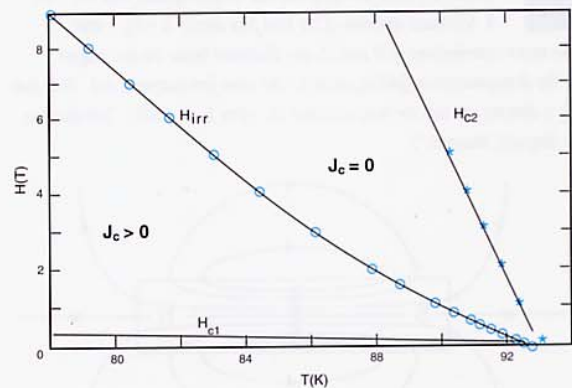

F. DEMAGNETIZATION CORRECTIONS

21

Magnetization as a function of the logarithm of time for a thin film sample of the high temperature superconductor $\text{YBa}_2\text{Cu}_3\text{O}_7$. The slope of the curve gives a flux creep relaxation rate. The sample was cooled in zero applied field after which a field $H = -10 \text{ kOe}$ was applied and the magnetic moment measured.

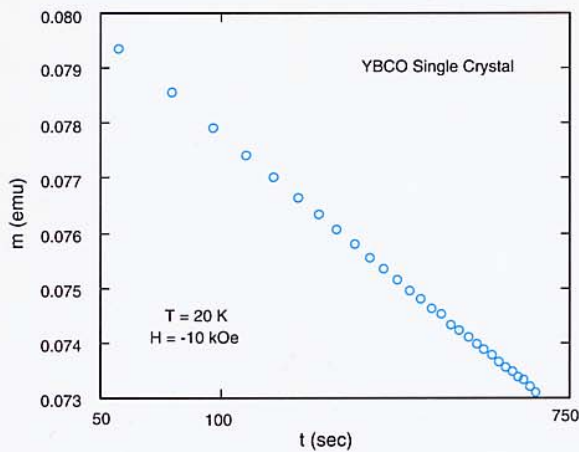

22

Shown is a hard ferromagnetic bar in zero applied field ($H_0 = 0$).

A. Schematic diagram of the total flux density $B = H_d + 4\pi M$.

The vector contributions of M and H_d are illustrated below the bar magnet.

B. The demagnetization field H_d alone for the same ferromagnetic rod. Note that H_d is directed opposite the magnetization M . [After B. D. Cullity, "Introduction to Magnetic Materials".]

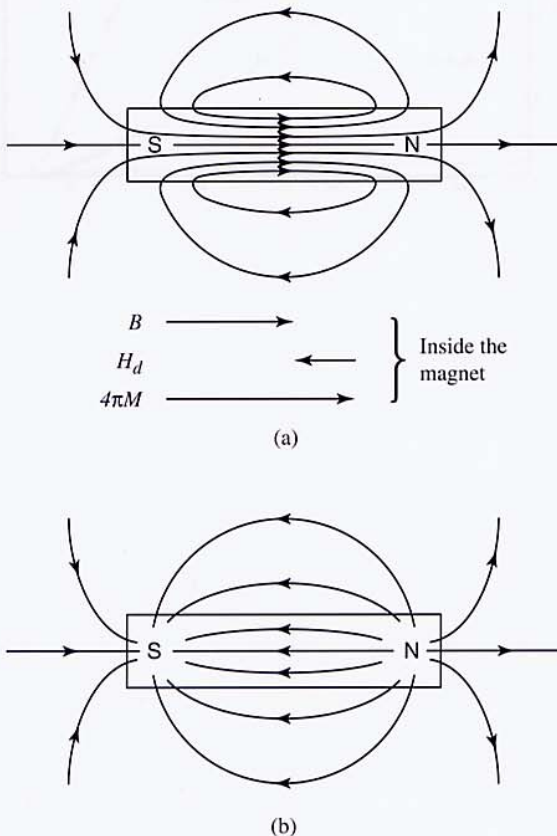

demagnetized) and the magnetization value is lower than should be observed.

Thus, the J_c value is underestimated. Hence, the choice of scan length is critical when determining the magnitude of irreversible behavior. In general, the shorter the scan length the better. But from experience a scan length on the order of 2.5 cm on the MPMS seems to be a good compromise. A Technical Advisory on this subject is available.

Time Dependence

Certain types of magnetic irreversibilities have a measurable time dependence. Two of the more notable examples are high temperature superconductors and spin glasses. In superconductors the decrease in magnetization in time is attributed to flux creep. Flux creep results from the thermal activation of flux vortices out of their pinning sites. By measuring M as a function of time a flux creep rate can be determined. From a plot of M versus the logarithm of time, as shown in Figure 21, a slope related to the flux creep rate can be extracted.

F. DEMAGNETIZATION CORRECTIONS

When measuring a sample with a large magnetization value, it is often important to make *demagnetization corrections*. In this case "demagnetization" does not refer to the process of reducing the remanent magnetization, but rather is associated with the fact that the field H inside the sample depends on the shape of the sample. The origin of the demagnetization effect is usually described in terms of another magnetic field, the demagnetization field H_d , that results from the separation of hypothetical magnetic charge associated with the sample's magnetization M (see recommended reading to find a more complete discussion). The total H field inside the sample is given by $H = H_0 + H_d$, where H_0 is now the applied field produced by the current in a magnet coil and H_d is the demagnetization field. The demagnetization field is given by $H_d = -NM$ where N is the shape-dependent demagnetization factor and M is the magnetization of the material. This correction can be particularly important when measuring a strongly magnetic material. For a long, thin sample in a field parallel to its long axis, $N = 0$. For a short, flat sample in a perpendicular field, on the other hand, the demagnetization correction (NM) can be enormous. The value of N has a range $0 \leq N \leq 1$ in SI units and $0 \leq N \leq 4\pi$ in cgs units.

Shown in Figure 22 is a schematic diagram of a magnetized piece of ferromagnetic material in zero applied field ($H_0 = 0$). Figure 22a shows the B field (sum of H and M) for this ferromagnet while Figure 22b shows the field H alone. Since $H_0 = 0$, the field H inside the sample is just the demagnetization field H_d . The vectors M , B , and H_d inside the sample are also shown in Figure 22. It can be seen that for a ferromagnet H_d is negative, thereby reducing H inside the sample. In the case of a

superconductor, M is negative so H_d will be positive, leading to an increase of H inside a superconducting sample. When an external field (H_0) is applied, H_d will change with the magnetization. However, it is the total H field inside the sample ($H_0 + H_d$) that will determine M . Therefore an $M(H)$ curve should be plotted as a function of the total internal field $H = H_0 + H_d$, not the applied field H_0 .

When measuring an isotropic ferromagnetic film, for example, the $M(H_0)$ curve observed for H_0 parallel to the plane of the film will be very different than that for H_0 perpendicular to the film plane. When H_0 is perpendicular there is a large demagnetization field in the film that reduces the total H , requiring a larger applied field H_0 to saturate the film than would be required when H_0 is parallel to the film plane. However, at saturation the same value of magnetization, M_s , will be observed in both cases.

To be able to accurately apply this simple demagnetization correction to H_0 requires that the demagnetization field be uniform throughout the sample. The only sample shape for which a uniform field can exist throughout the sample is an ellipsoid. Therefore it is common practice to approximate the demagnetizing factor N for a sample by considering the "maximum-enclosed-ellipsoid," which is the ellipsoid with shape and dimensions that allow it to be enclosed in the sample and fill the maximum volume. Tables and plots of calculations of N values for ellipsoids are available (see recommended reading). Since most samples are not ellipsoids, this correction method should be considered only approximate. Sometimes materials are shaped into spheres so that this correction method can be used more accurately.

G. MAGNETIC CHARACTERIZATION OF A NEW MATERIAL

When presented with a new or unknown material, one often wants to quickly determine the general magnetic properties of the sample. The following procedure comes with no guarantees, but rather is intended as a systematic plan to help identify the magnetic behavior present in the sample. It is also only a starting point, because the more complete characterization of a sample typically requires detailed measurements once the regions of particular interest have been identified.

After determining the safe range of temperatures for the sample, an $M(T)$ sweep with a very low magnetic field ($H \sim 50$ to 100 Oe) should be run over the full temperature range. A temperature resolution of 5 K at low temperature and 10 K at higher temperatures is often suitable. Both superconductivity and ferromagnetism can stand out in such a scan. If one of these properties is identified, detailed measurements of that property can proceed.

G. MAGNETIC CHARACTERIZATION OF A NEW MATERIAL

23

Magnetization as a function of temperature for UNi_2Si_2 at a series of evenly spaced applied magnetic fields. The fields range from $H = 5000$ to $H = 50000$ Oe in steps of 5000 Oe. A) The temperature range from 85 to 110 K where a metamagnetic transition region exists (from 85 to about 103 K) and a regular ferromagnetic region exists (from about 103 to about 110 K). In a metamagnetic transition the system goes from antiferromagnetic to ferromagnetic. At the lower temperatures there is a cluster of points at the lower field. The lower field cluster has an $M(H)$ curve characteristic of an antiferromagnet. Then there is a sharp increase in magnetization followed by another cluster of points at the highest fields. The cluster at the high fields is the magnetic saturation associated with a ferromagnet while in between is the transition from one magnetic behavior to the other. B) In the region near and above the ferromagnetic transition the spacing of the points at a given temperature suggest paramagnetic behavior.

A.

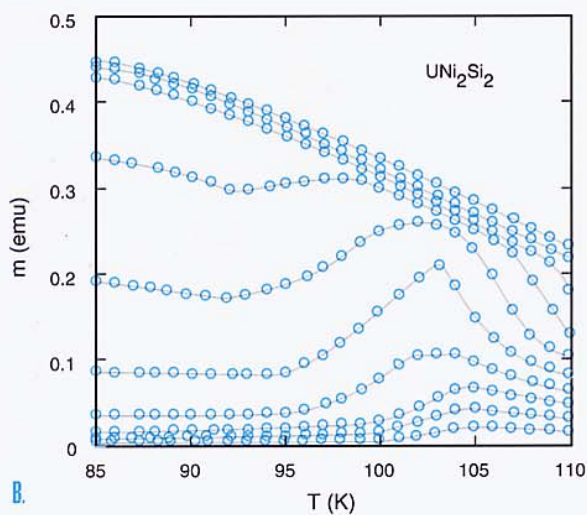

B.

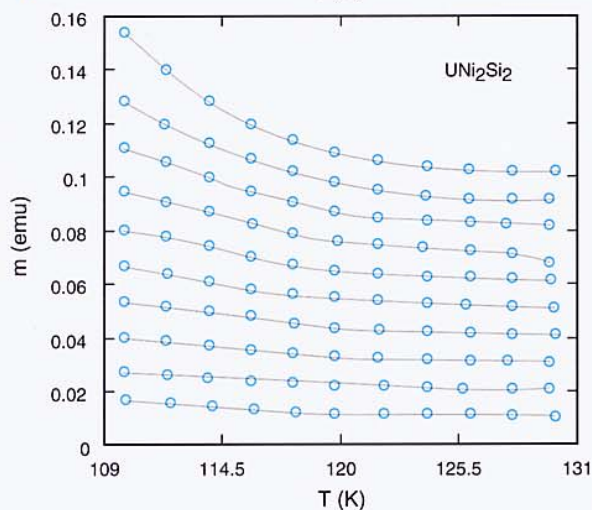

Depending on the available time, the next procedure in a general search would be to measure $M(T)$ again over the full temperature range but now at a series of equally spaced values of H (eg. $\Delta H \sim 5$ kOe). The advantage of this kind of plot can be seen in Figure 23, for a sample of UNi_2Si_2 . If the $M(H)$ curve at a given temperature is linear, then the $M(T)$ curves taken with even field increments will be evenly spaced. If the $M(H)$ curve saturates at a certain temperature, then the points will get closer together as M saturates. Other interesting information, like a *spin flop* or *metamagnetic transitions* can often be identified from sets of $M(T)$ plots. Detailed measurements including history dependence can then proceed more efficiently with this information at hand.

A. TABLE OF CONVERSIONS

UNITS FOR MAGNETIC PROPERTIES

Quantity	Symbol	Gaussian & cgs emu ^a	Conversion factor, C ^b	SI & rationalized mks ^c
Magnetic flux density, magnetic induction	B	gauss (G) ^d	10^{-4}	tesla (T), Wb/m ²
Magnetic flux	Φ	maxwell (Mx), G·cm ²	10^{-8}	weber (Wb), volt second (V·s)
Magnetic potential difference, magnetomotive force	U, F	gilbert (Gb)	$10/4\pi$	ampere (A)
Magnetic field strength, magnetizing force	H	oersted (Oe), ^e Gb/cm	$10^3/4\pi$	A/m ^f
(Volume) magnetization ^g	M	emu/cm ^{3h}	10^3	A/m
(Volume) magnetization	$4\pi M$	G	$10^3/4\pi$	A/m
Magnetic polarization, intensity of magnetization	J, I	emu/cm ³	$4\pi \times 10^{-4}$	T, Wb/m ²ⁱ
(Mass) magnetization	σ, M	emu/g	$\frac{1}{4\pi \times 10^{-7}}$	A·m ² /kg Wb·m/kg
Magnetic moment	m	emu, erg/G	10^{-3}	A·m ² , joule per tesla (J/T)
Magnetic dipole moment	j	emu, erg/G	$4\pi \times 10^{-10}$	Wb·m ⁱ
(Volume) susceptibility	χ, κ	dimensionless, emu/cm ³	$\frac{4\pi}{(4\pi)^2} \times 10^{-7}$	dimensionless henry per meter (H/m), Wb/(A·m)
(Mass) susceptibility	χ_ρ, κ_ρ	cm ³ /g, emu/g	$\frac{4\pi \times 10^{-3}}{(4\pi)^2} \times 10^{-10}$	m ³ /kg H·m ² /kg
(Molar) susceptibility	$\chi_{\text{mol}}, \kappa_{\text{mol}}$	cm ³ /mol, emu/mol	$\frac{4\pi \times 10^{-6}}{(4\pi)^2} \times 10^{-13}$	m ³ /mol H·m ² /mol
Permeability	μ	dimensionless	$4\pi \times 10^{-7}$	H/m, Wb/(A·m)
Relative permeability ^j	μ_r	not defined		dimensionless
(Volume) energy density, energy product ^k	W	erg/cm ³	10^{-1}	J/m ³
Demagnetization factor	D, N	dimensionless	$1/4\pi$	dimensionless

a. Gaussian units and cgs emu are the same for magnetic properties. The defining relation is $B = H + 4\pi M$.

b. Multiply a number in Gaussian units by C to convert it to SI (e.g., $1 \text{ G} \times 10^{-4} \text{ T/G} = 10^{-4} \text{ T}$).

c. SI (*Système International d'Unités*) has been adopted by the National Bureau of Standards. Where two conversion factors are given, the upper one is recognized under, or consistent with, SI and is based on the definition $B = \mu_0(H + M)$, where $\mu_0 = 4\pi \times 10^{-7} \text{ H/m}$. The lower one is not recognized under SI and is based on the definition $B = \mu_0 H + J$, where the symbol I is often used in place of J .

d. $1 \text{ gauss} = 10^5 \text{ gamma } (\gamma)$.

e. Both oersted and gauss are expressed as $\text{cm}^{-1/2} \cdot \text{g}^{1/2} \cdot \text{s}^{-1}$ in terms of base units.

f. A/m was often expressed as "ampere-turn per meter" when used for magnetic field strength.

g. Magnetic moment per unit volume.

h. The designation "emu" is not a unit.

i. Recognized under SI, even though based on the definition $B = \mu_0 H + J$. See footnote c.

j. $\mu_r = \mu/\mu_0 = 1 + \chi$, all in SI. μ_r is equal to Gaussian μ .

k. $B \cdot H$ and $\mu_0 M \cdot H$ have SI units J/m³; $M \cdot H$ and $B \cdot H/4\pi$ have Gaussian units erg/cm³.

B. RECOMMENDED READING***Introduction to Magnetic Materials,***

B. D. Cullity, Addison-Wesley, 1972, ISBN# 0-201-01218-9.

This is the simplest introduction to magnetism in materials that is available. It is an engineering textbook that discusses many practical matters; an essential reference for anyone working on the magnetism of materials. Plots and tables of demagnetization coefficients are included.

The Physical Principles of Magnetism,

A. H. Morrish, R. E. Krieger, Wiley (no longer in print), 1983, ISBN# 0-88275-670-2.

This is a very complete physics textbook quantitatively describing the physical properties of magnetic materials.

Magneto-Chemistry,

R. L. Carlin, Springer-Verlag, 1986, ISBN# 0-387-15816-2.

This is an introduction to magnetism primarily in molecular systems.

Long Range Order in Solids,

R. M. White and T. H. Geballe, Academic Press, 1979, ISBN# 0-12-607777-0.

This is an advanced solid state physics textbook that discusses long range order in general and in various specific cases (i.e., magnetic and superconducting transitions). It is an excellent source of references to the literature on magnetism.

Introduction to Superconductivity,

A. C. Rose-Innes and E. H. Rhoderick, Pergamon, 1978, ISBN# 0-08-021651-8.

This is a fairly accessible development of superconductivity requiring a modest knowledge of solid state physics.

Superconductivity of Metals and Alloys,

P. G. DeGennes, Addison-Wesley, 1966, ISBN# 0-201-51007-3.

This is a graduate-level physics textbook on superconductivity and is regarded as one of the classic texts on superconductivity.

Introduction to Superconductivity,

M. Tinkham, R. E. Krieger, Pubnet, 1980, ISBN# 0-89874-049-5.

This is a graduate-level physics textbook on superconductivity and is also regarded as one of the classic texts on superconductivity.

Quantum Design, Inc.
11578 Sorrento Valley Rd
San Diego, CA 92121 USA
Tel: 1-858-481-4400 ext. 106
Fax: 1-858-481-7410
Mobile: 1-619-892-8098
Email: info@qdusa.com
Web: www.qdusa.com